

drena

drenaflex

drena

es una marca de / is a brand of
Industrias Plastisan S.A.
Travesía Industrial, 23 bis
08907 L'Hospitalet de Llobregat
Barcelona, Spain
T. +34 933 364 300
plastisan@plastisan.com
www.drena.es
www.plastisan.com



ref.: 71700

adaptador válvula roscada DRENAFLEX

threaded waste adapter DRENAFLEX

adaptateur bonde fileté DRENAFLEX

adaptador válvula roscada DRENAFLEX

adattatore piletta filettata DRENAFLEX

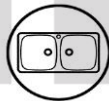
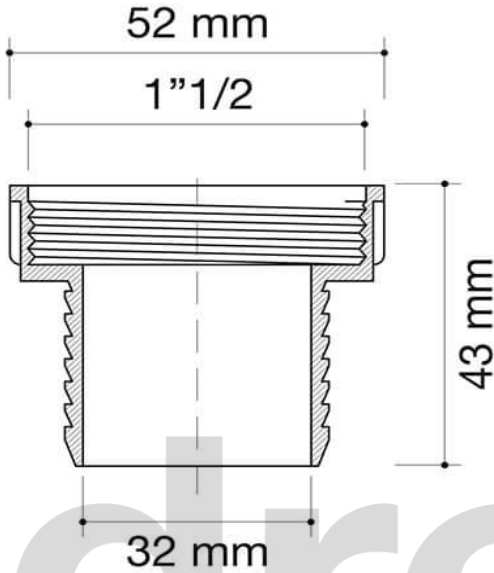

8 421964 717001

blanco / white / blanc / branco / bianco
superbag / superbag / superbag / superbag / superbag
PE

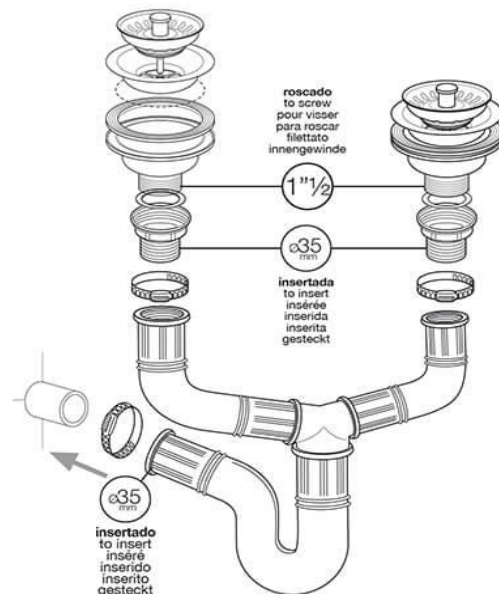

este documento contiene información confidencial propiedad de Industrias Plastisan, S.A. ni el documento ni la información contenida pueden ser difundidas ni reproducidas total o parcialmente sin el consentimiento expreso de Industrias Plastisan, S.A.

this document contains confidential information that is proprietary to Industrias Plastisan, S.A. neither the document nor the information contained therein should be disclosed or reproduced in whole or in part, without express written consent of Industrias Plastisan, S.A.