

Recibidor Nanda

1 cajón 2 espejos

Instrucciones de montaje



Te aconsejamos

Ordena y cuenta las piezas y herrajes

Habilita una zona para el montaje

No fuerces los tornillos y los elementos de montaje

Sigue paso a paso las instrucciones de montaje

Las herramientas que necesitas (no incluidas)

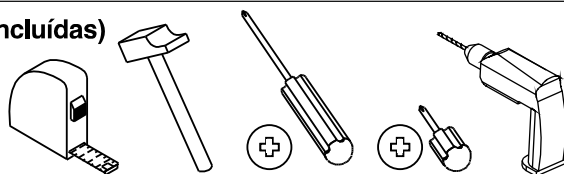

Los herrajes que encontrarás en el kit

Gm25 x 1 N°710043 	Exc x 16 N°721016 N°721017 	Lz x 1 N°710251 	Rei x 8 0 1 2 3 4 5 cm N°721020
Pun x 20 N°720006 	Esc x 2 N°721093 	Tac x 4 N°721063 	Tor x 4 0 1 2 3 4 5 cm N°721118
Tpp x 12 N°721127 	Tac x 6 N°721045 	Colg x 4 N°721094 	Trd x 1 N°722025

Bolsa para el cajón

Exc x 4 N°721126/721017 	Aut x 4 0 1 2 3 4 5 cm N°710250 	Eu x 4 1 2 3 4 5 cm N°721014 	Rei x 4 0 1 2 3 4 5 cm N°721020
--------------------------------	---	--	---

Las piezas incluidas en el kit



AVISO: este mueble puede contener piezas innecesarias para el montaje, pero necesarias para el embalaje.

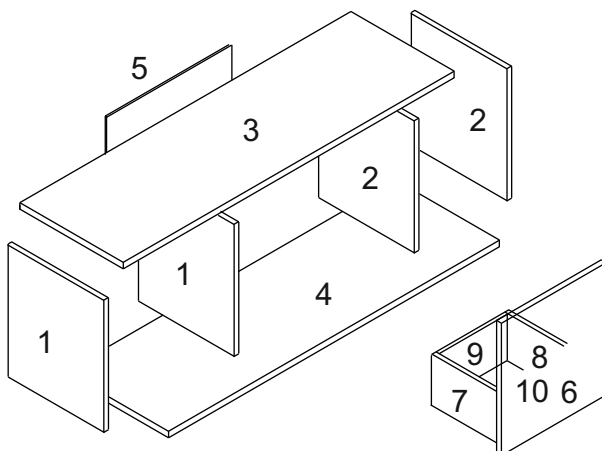
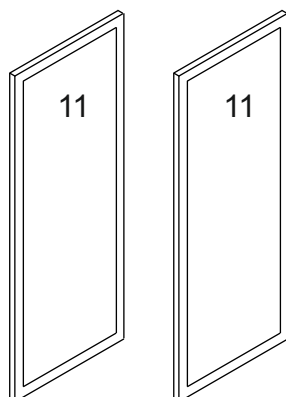

Las piezas incluidas en el kit

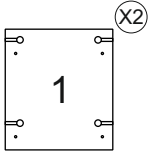

Centro izqdo
248x278 mm
1006055

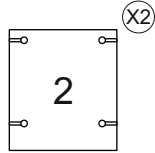

Centro drcho
248x278 mm
1006056

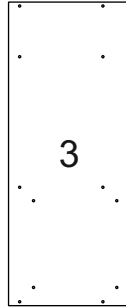

Techo
700x280 mm
1006031



Suelo
700x280 mm
1006032



Trasera
313x276 mm
910605

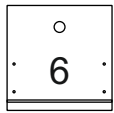

Frente cajón
242x242 mm
1006060

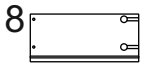
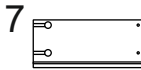

Costillas later.
250x110 mm
1250115/1250116

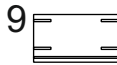

Costilla fondo
196x110 mm
1196119

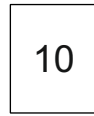

Fondo cajón
250x206 mm
810604

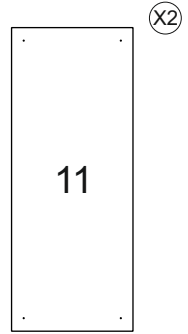

Espejo
700x280 mm
1006010

El módulo puede montarse de diferentes maneras: ¡elige la tuya!

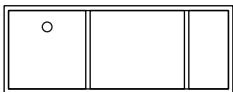

Cajón a la izquierda



Cajón a la derecha



Cajón arriba

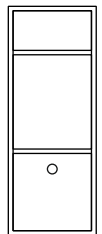

Cajón abajo

1

El primer paso es el montaje de los herrajes

Exc x 8

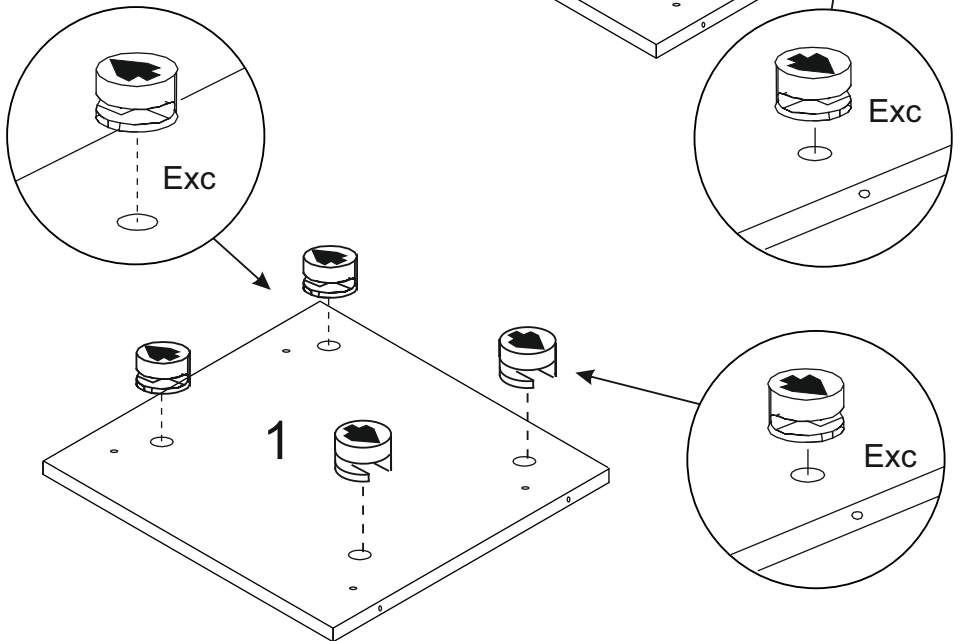
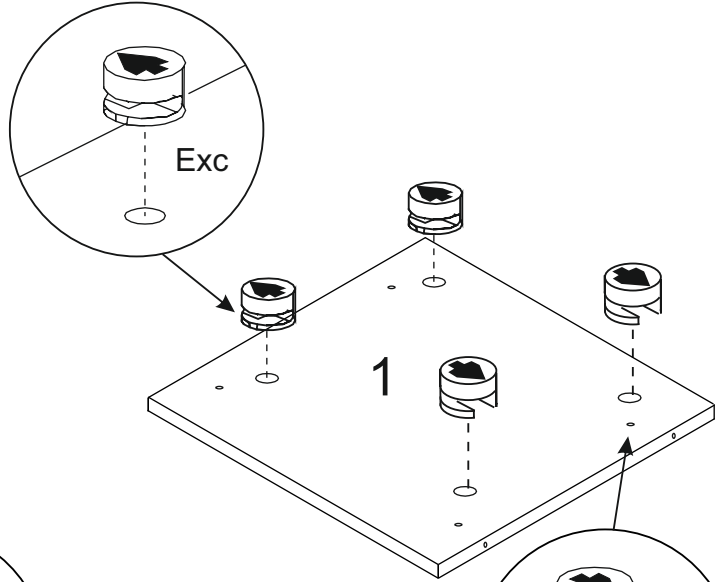
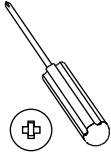

Exc x 8

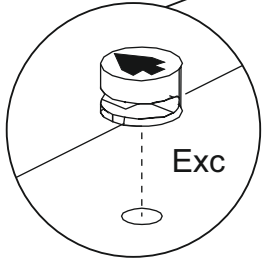
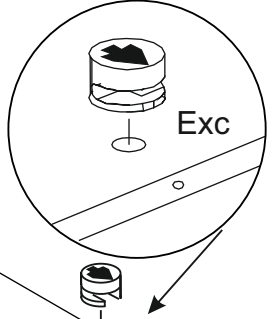
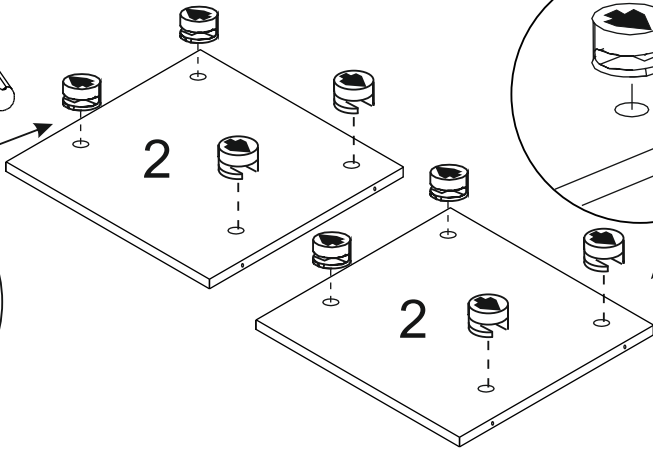
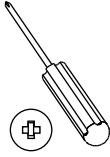

Exc x 16

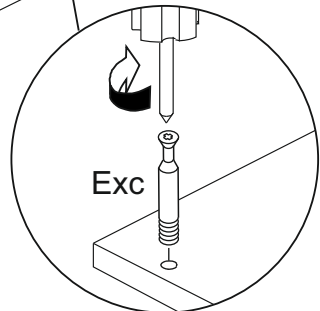
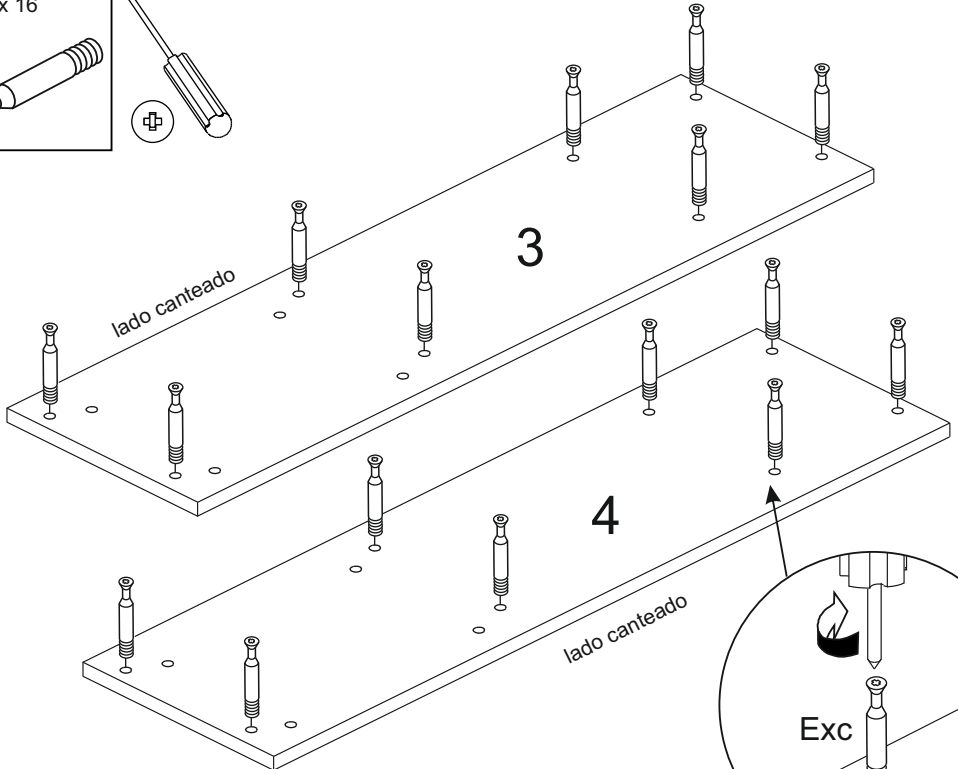
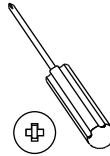
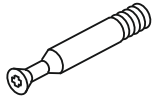

1

Rei x 8



Colg x 4



Tac x 6

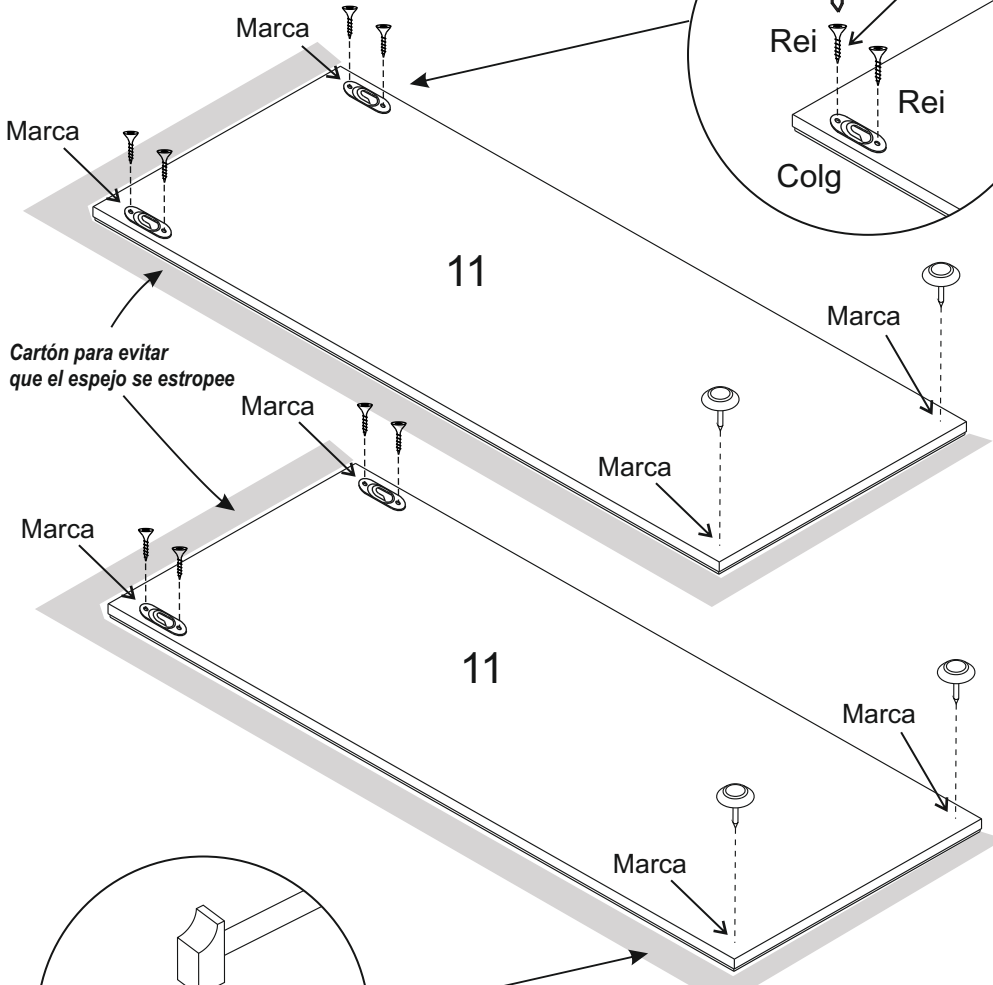
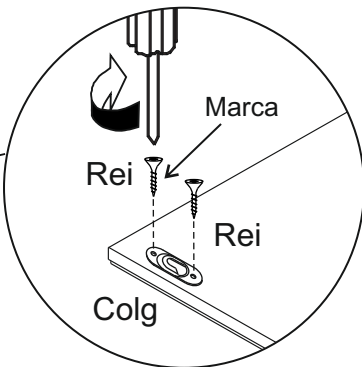
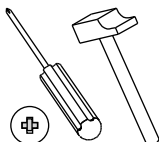

Cartón para evitar que el espejo se estropee

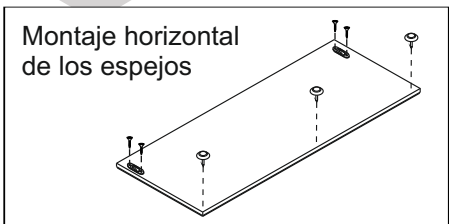

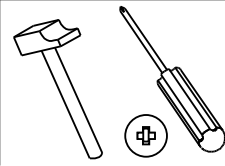
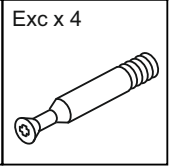
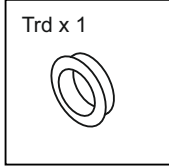

Bolsa para el cajón

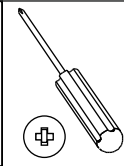
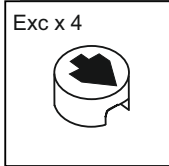
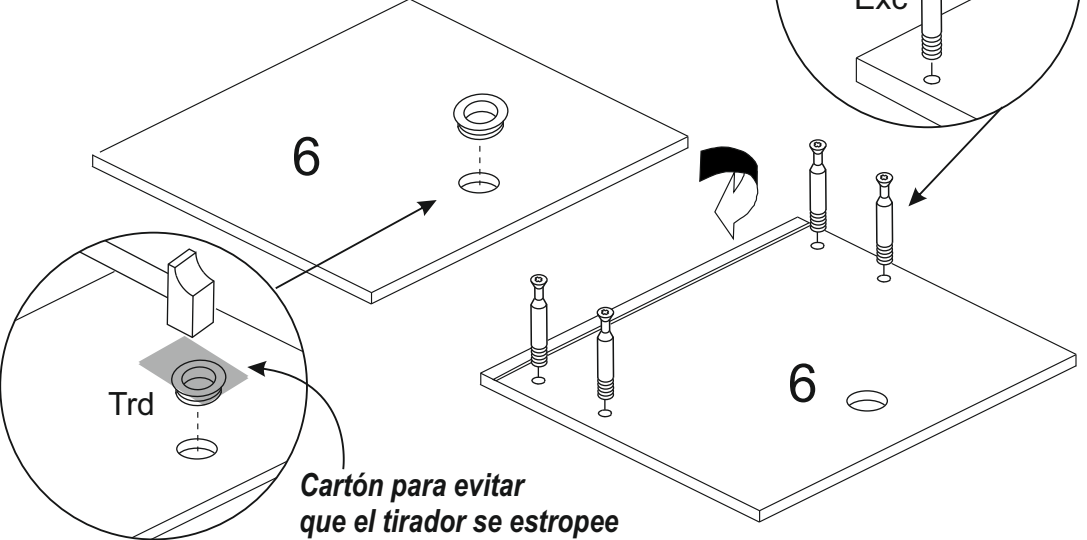
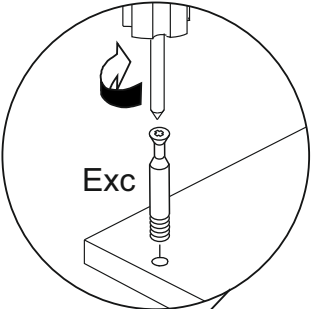

Bolsa para el cajón

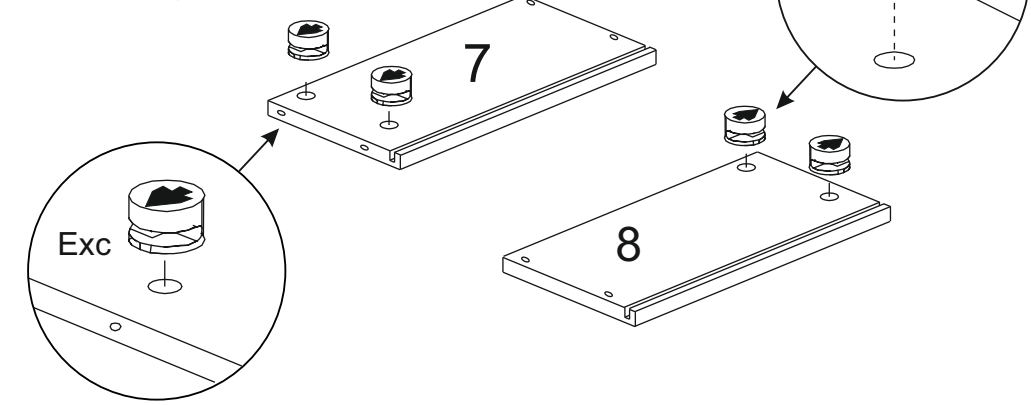
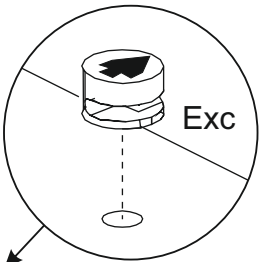

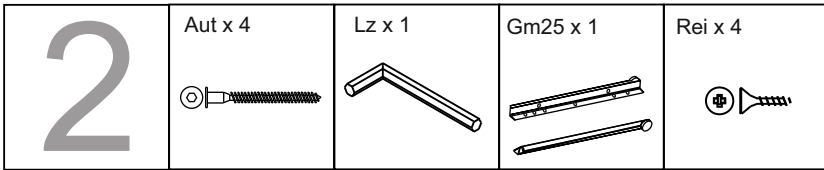

Bolsa para el cajón

Bolsa para el cajón

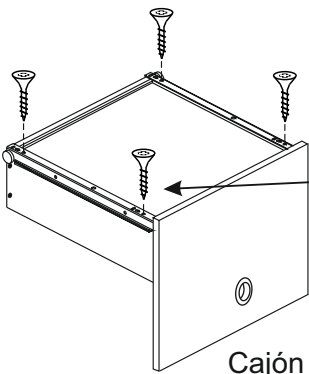
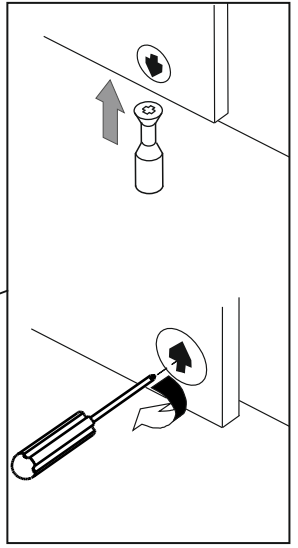
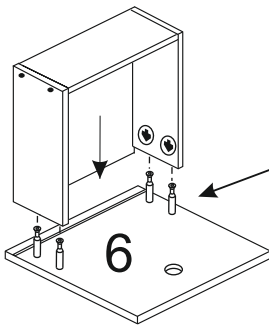
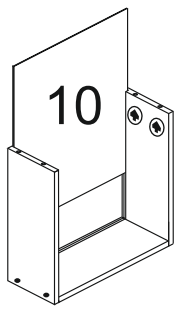
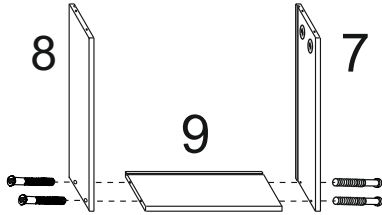
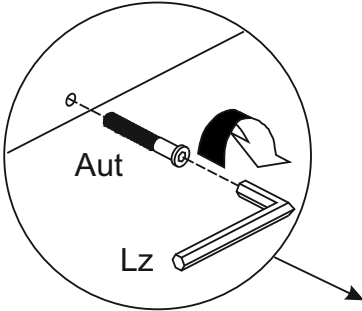
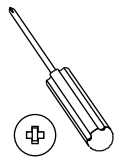

Cajón boca abajo

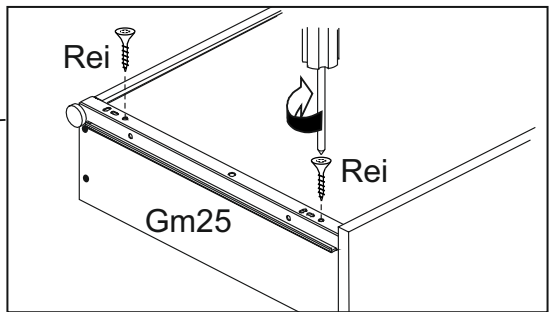

3

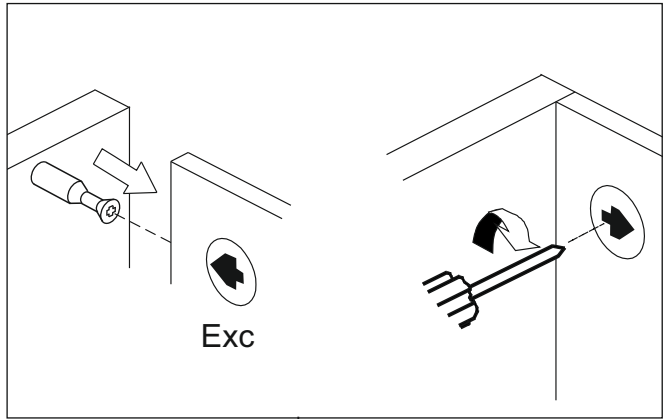
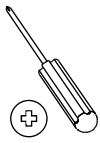

Agujeros

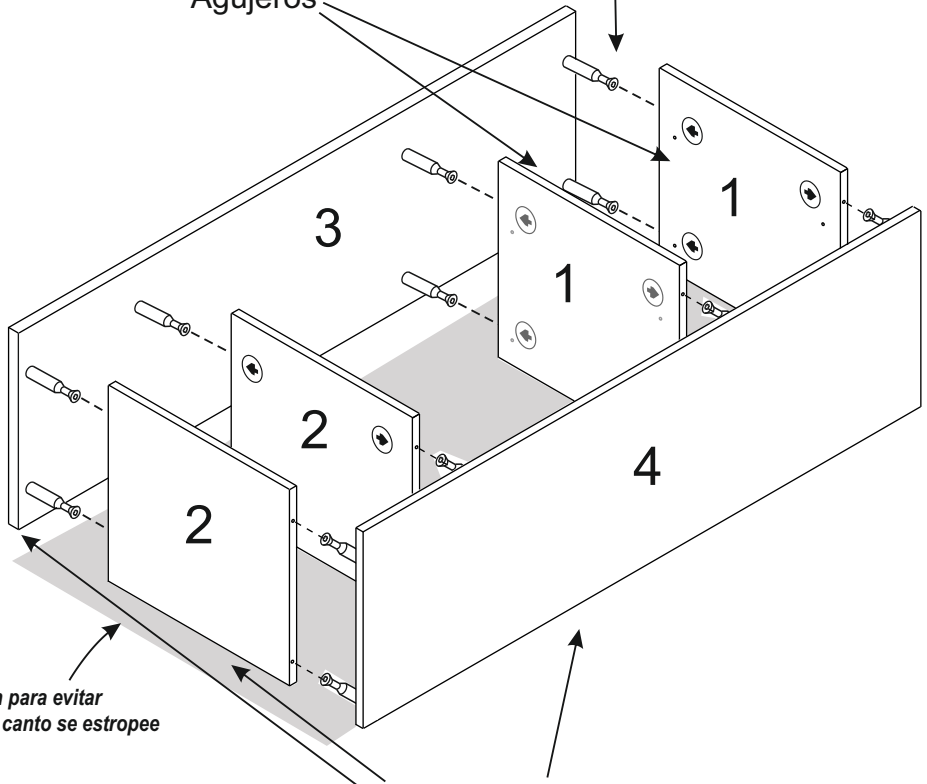

Cartón para evitar que el canto se estropee

Lados canteados

4

Esc x 2

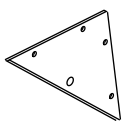

Pun x 20

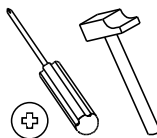
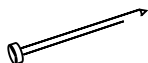

Ejemplo de montaje:
con el cajón a la izquierda

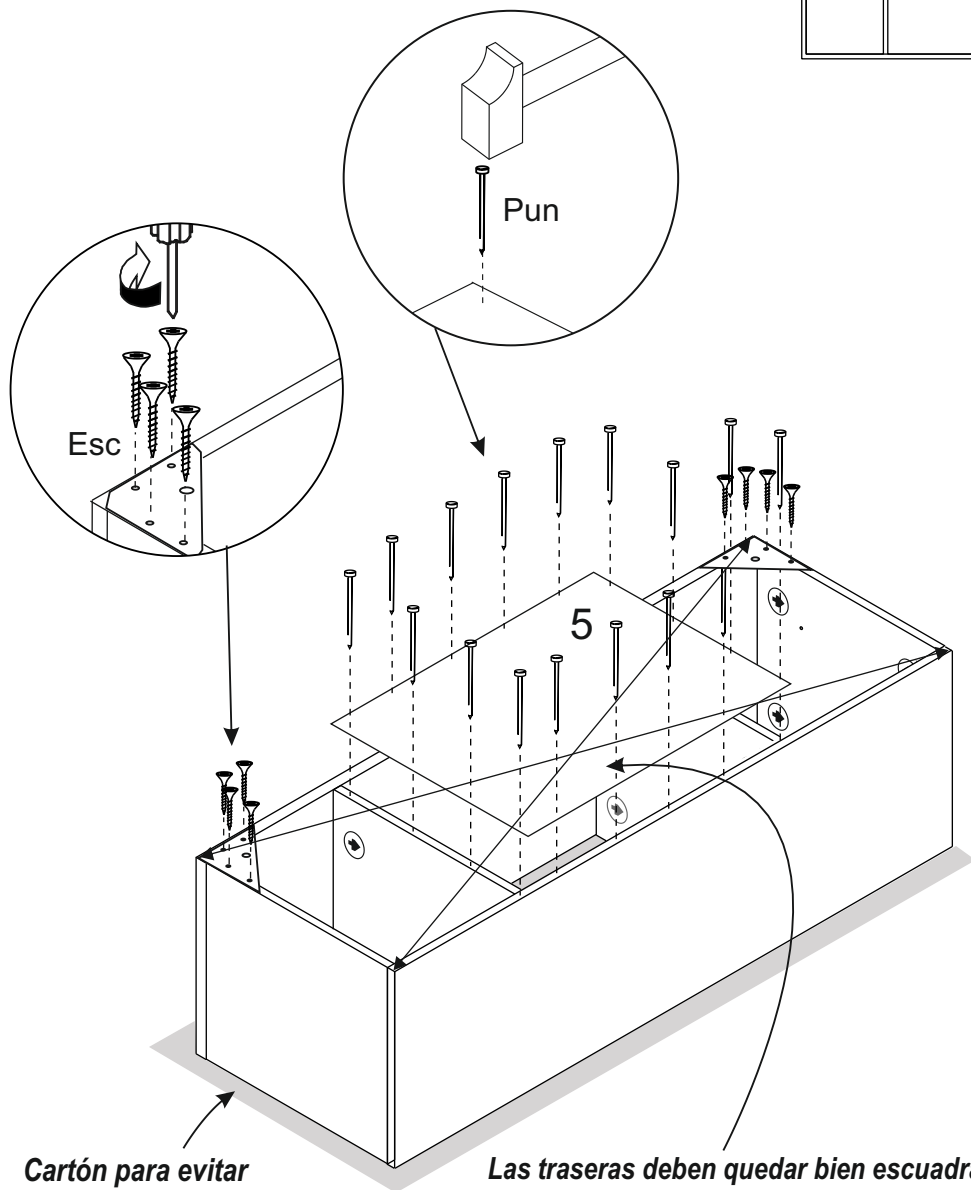

**Cartón para evitar
que el canto se estropee**

**Las traseras deben quedar bien escuadradas:
las diagonales deben medir igual**

5

Gm25 x 1

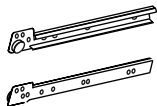

Eu x 4



Ejemplo de montaje:
con el cajón a la izquierda



Bolsa para el cajón

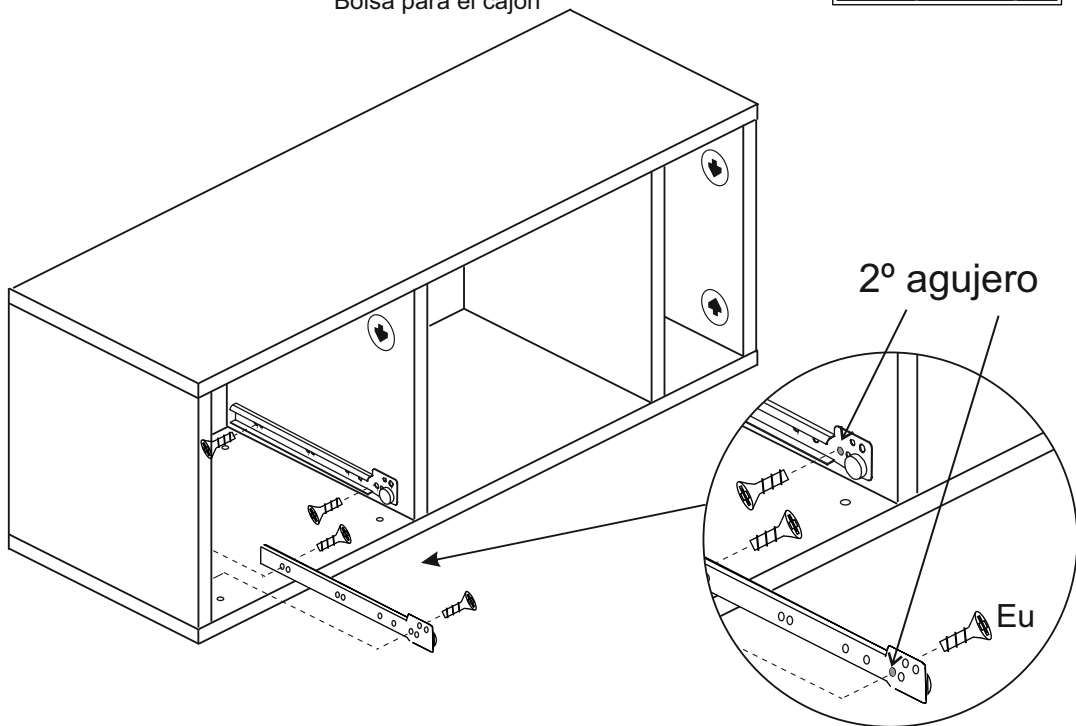

6

Esc x 2



Bolsa de escuadras

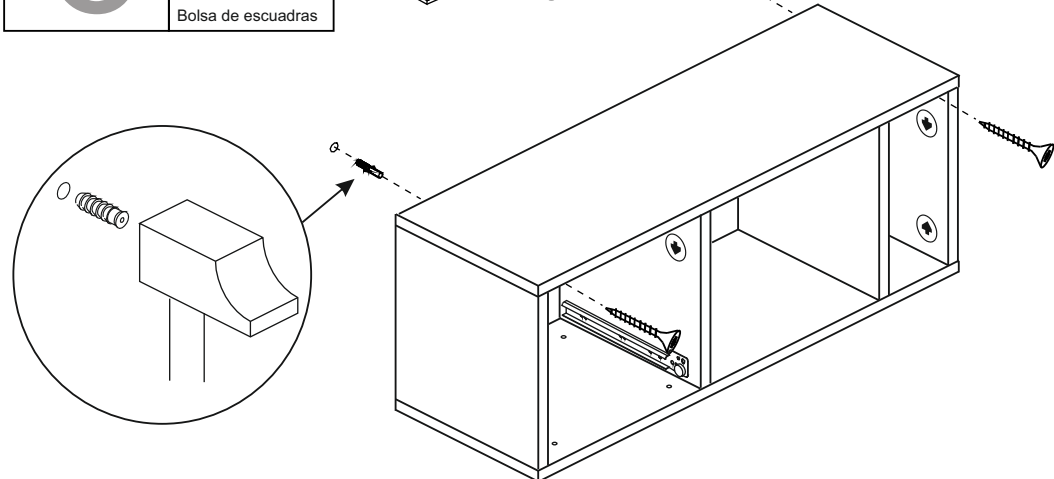
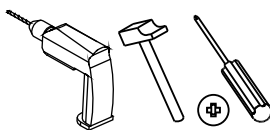

7

Tpp x 12



Tac x 4

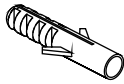

Tor x 4

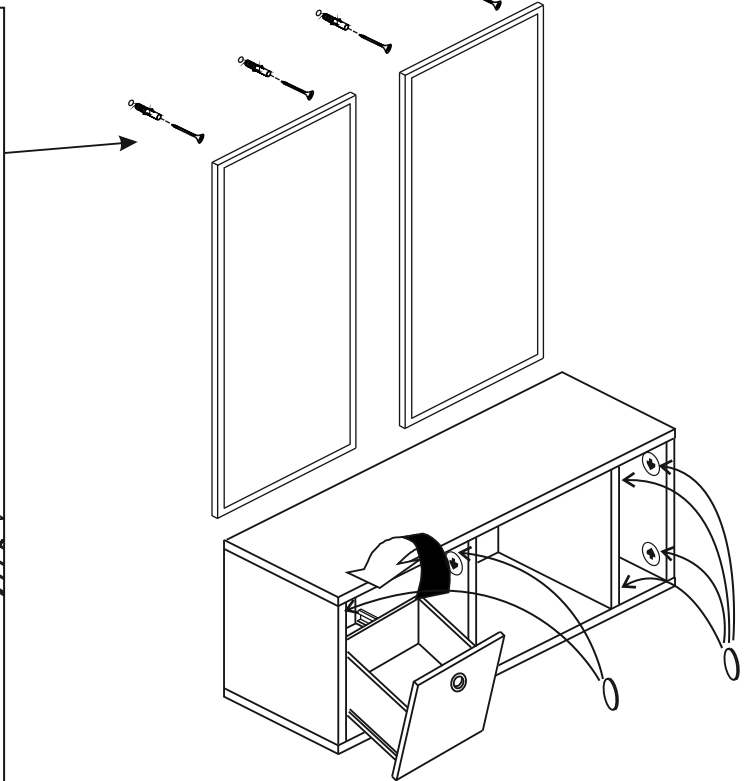
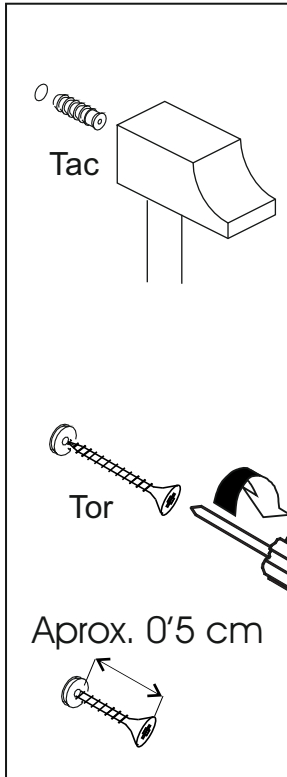
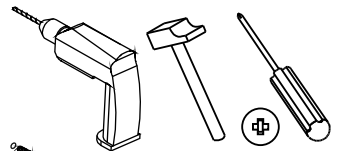
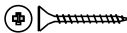

CONDICIONES DE USO Y MANTENIMIENTO

Producto de uso doméstico.

Evitar colocar el mueble cerca de fuentes de calor, de humedad o de una fuerte luz solar.

No lo limpie con productos abrasivos, ni disolventes.

Quitar el polvo antes de limpiarlo.

Utilizar un paño húmedo, limpio y sin pelos.

CONDIÇÕES DE USO E MANUTENÇÃO DO MÓVEL

Produto de uso doméstico.

Evitar colocar o móvel próximo a fontes de calor, de humidade ou exposto a luz solar intensa.

Não limpar com produtos abrasivos ou produtos de limpeza com solvente.

Eliminar o pó antes de qualquer processo de limpeza.

É recomendável utilizar um pano húmido, limpo e sem pelos.

ATENCIÓN AL CLIENTE
ATENDIMENTO AO CLIENTE

(+34)964 321 111

HORARIO: 8-13h 15-17:30h de lunes a viernes

Web: www.mueblespitarch.com
e-mail: comercial@mueblespitarch.com

LOTE 5107