

CABECERO 100 ELSA

ATENCIÓN AL CLIENTE

964 321 111

Web: www.mueblespitarch.com
e-mail: comercial@mueblespitarch.com

Pitarch
SYSTEM KIT MUEBLES

Las herramientas que necesitas (no incluidas)

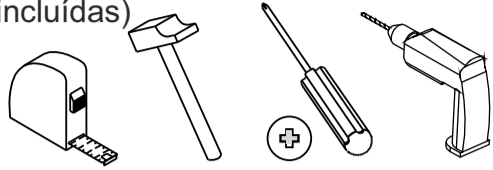

Las piezas incluidas en el kit

Los herrajes que encontrarás en el kit

Tir x 20 Nº721007 	Tac x 2 Nº721063 	Colg x 2 Nº721094 	Tac x 3 Nº721045
Tpt x 4 Nº721075 	Tor x 2 Nº721066 		

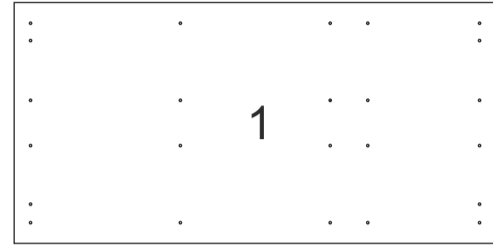

Pieza trasera
1000x500 mm
105875/605875/1005875

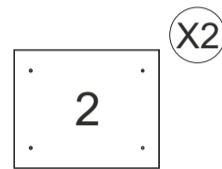

Pieza pequeña
300x245 mm
105721/605721/
1005721/1605721



Pieza grande
690x245 mm
105822/605822/
1005822/1605822

Te aconsejamos

Ordena y cuenta las piezas y herrajes

Habilita una zona para el montaje

No fuerces los tornillos y los elementos de montaje

Sigue paso a paso las instrucciones de montaje

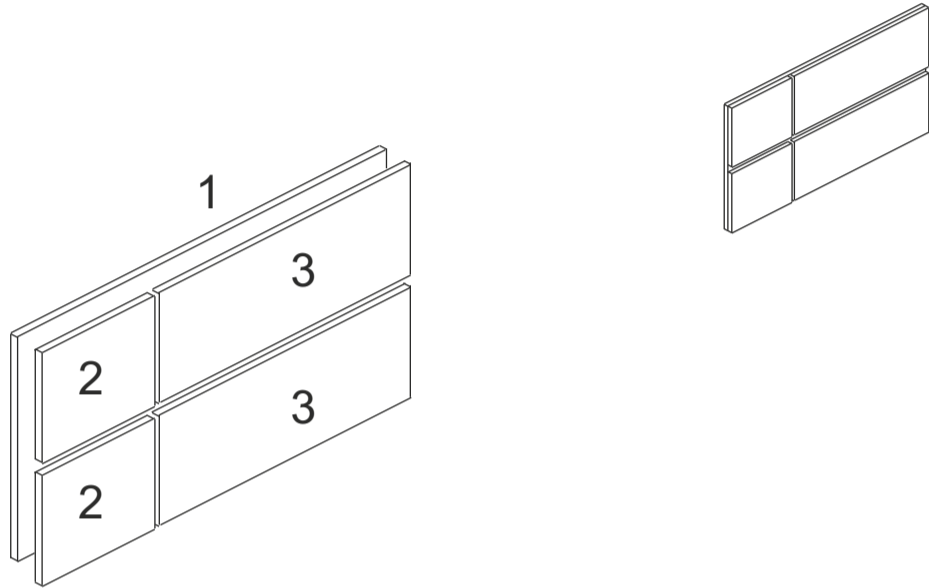

REF. 1058/6058/10058/16058
LOTE 5256/5257/5258

1

Tir x 20

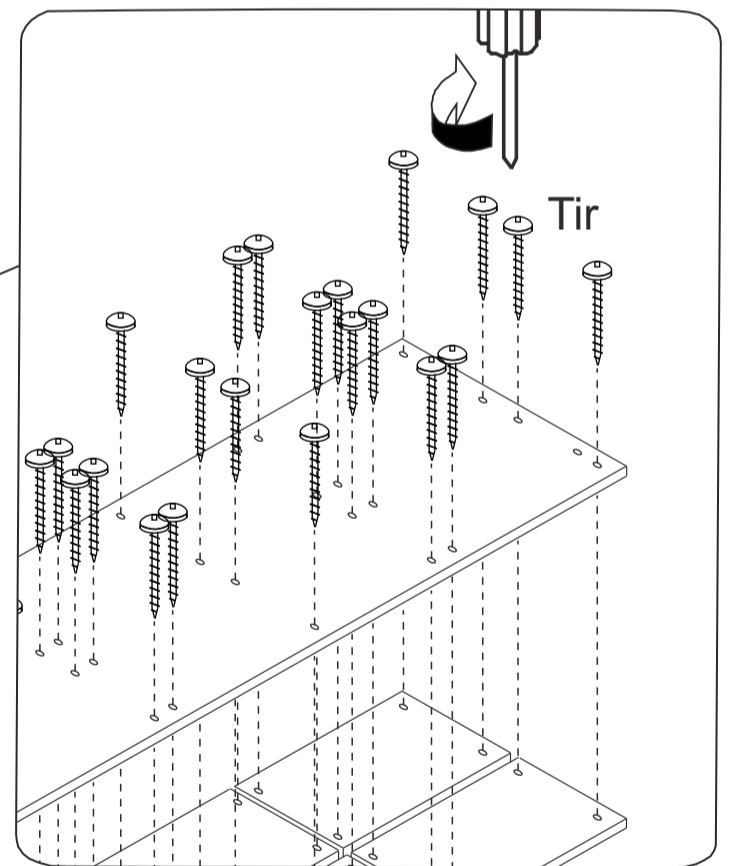
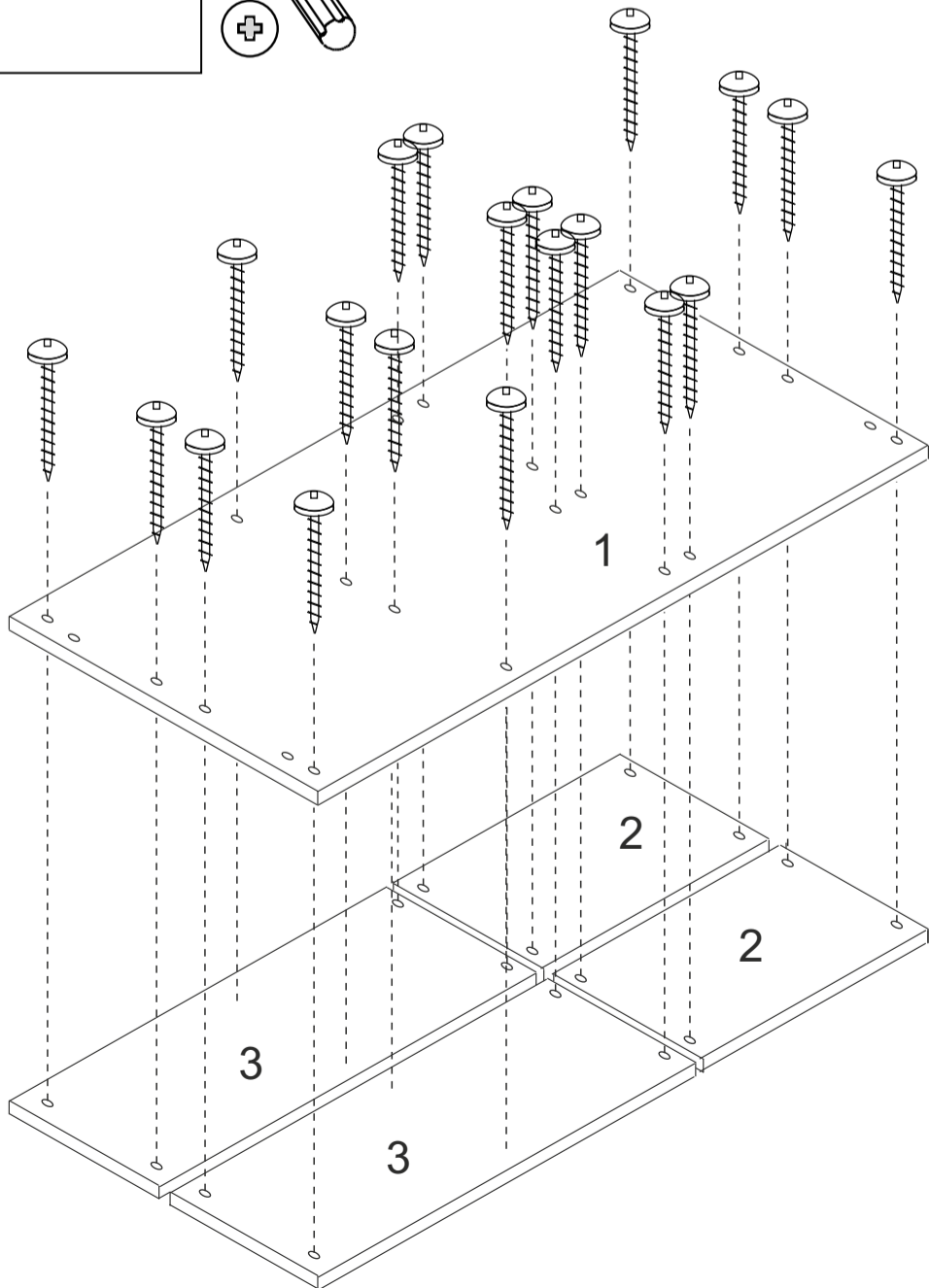
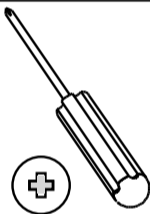
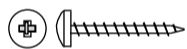

2

Tpt x 4



Colg x 2

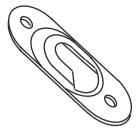

Tac x 3

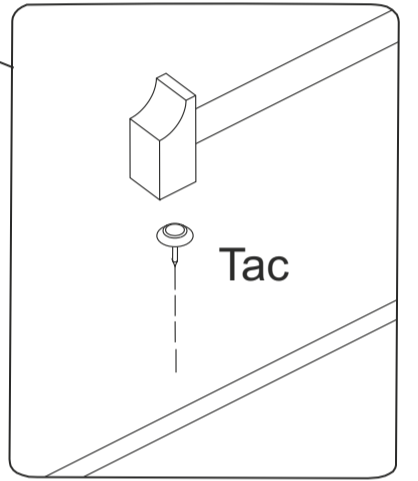
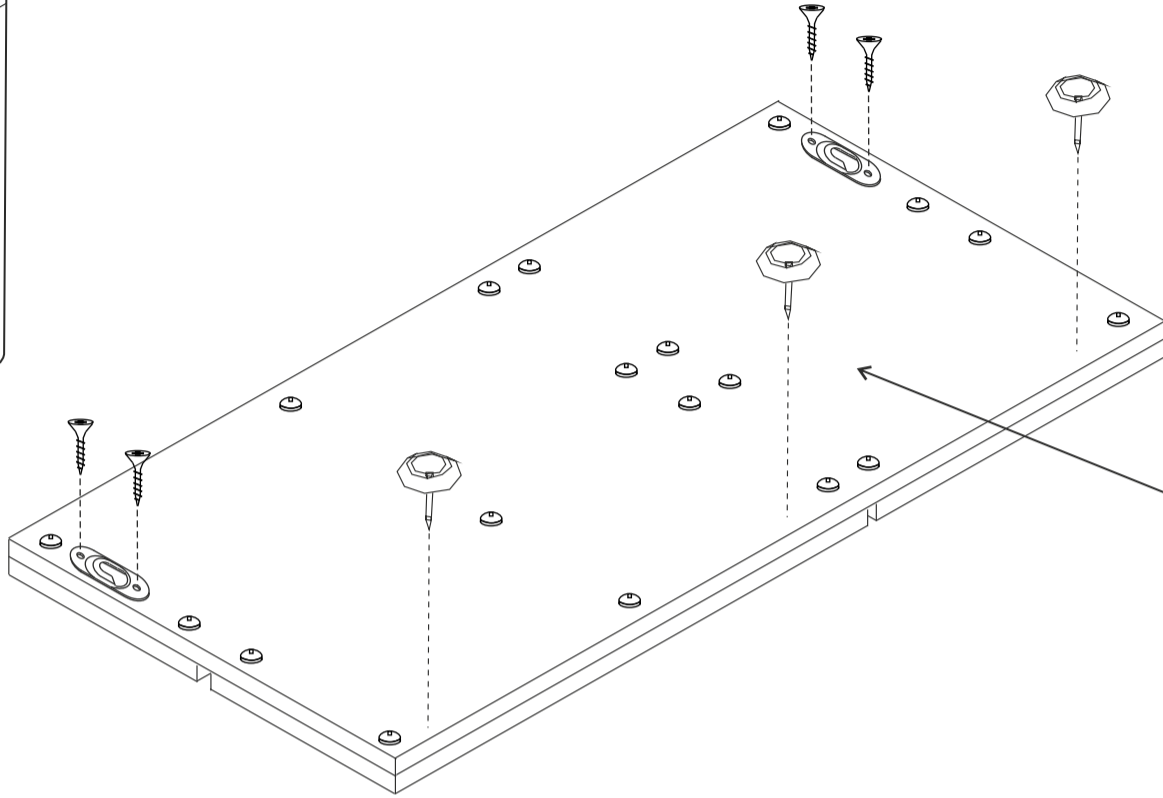
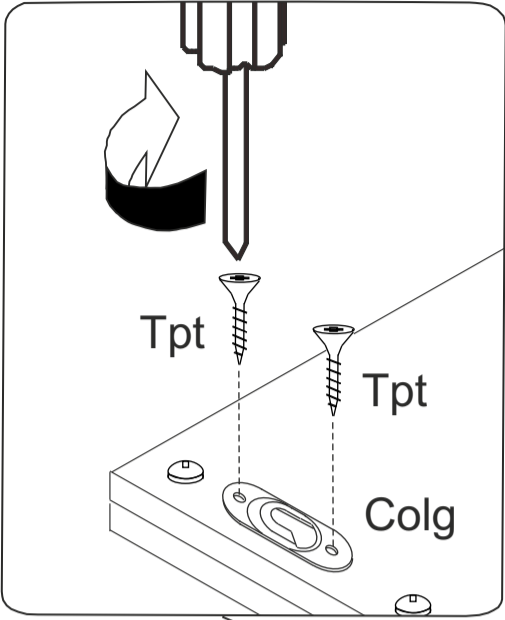
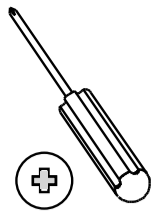
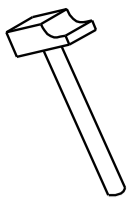

3

Tac x 2



Tor x 2

