

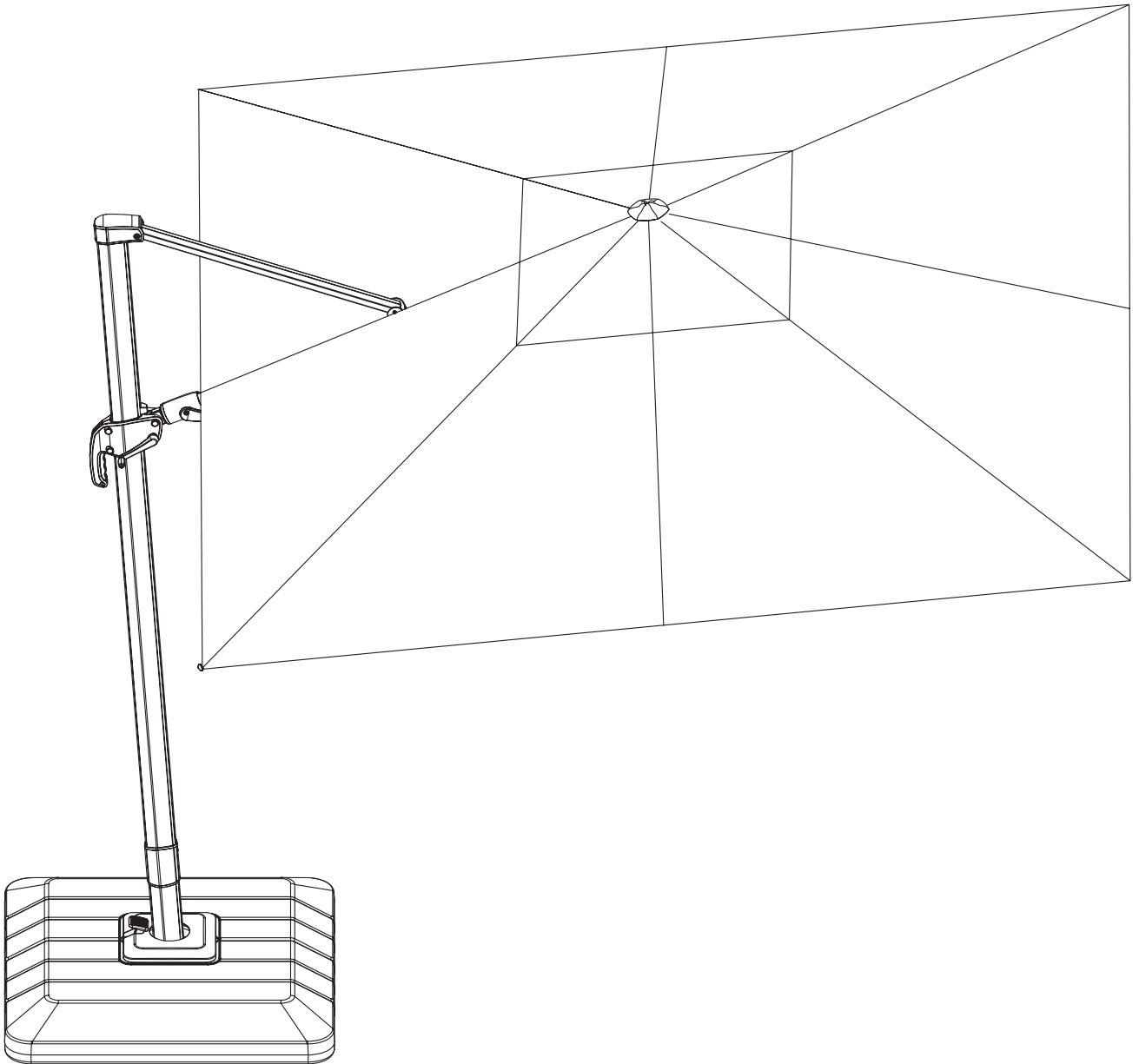

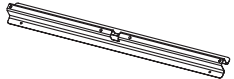







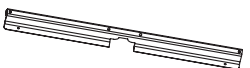
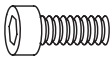
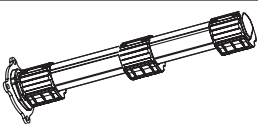





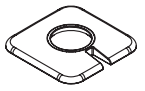

URA038017A

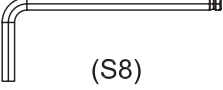

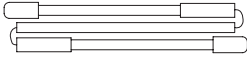
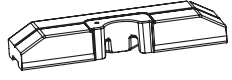
ENA:4024506652088
ENA:4024506656949

A	1		L	1	
B	1		AA	4	 (M10X25)
C	1		BB	4	 (M10X20)
D	1		CC	8	 (Φ10.5)
E	1		DD	1	 (M6X15)
F	1		EE	1	 (M6x10)
G	1		FF	1	 (S5)
H	1		GG	1	 (S8)
I	2		M	1	
J	2		N	1	
K	1				

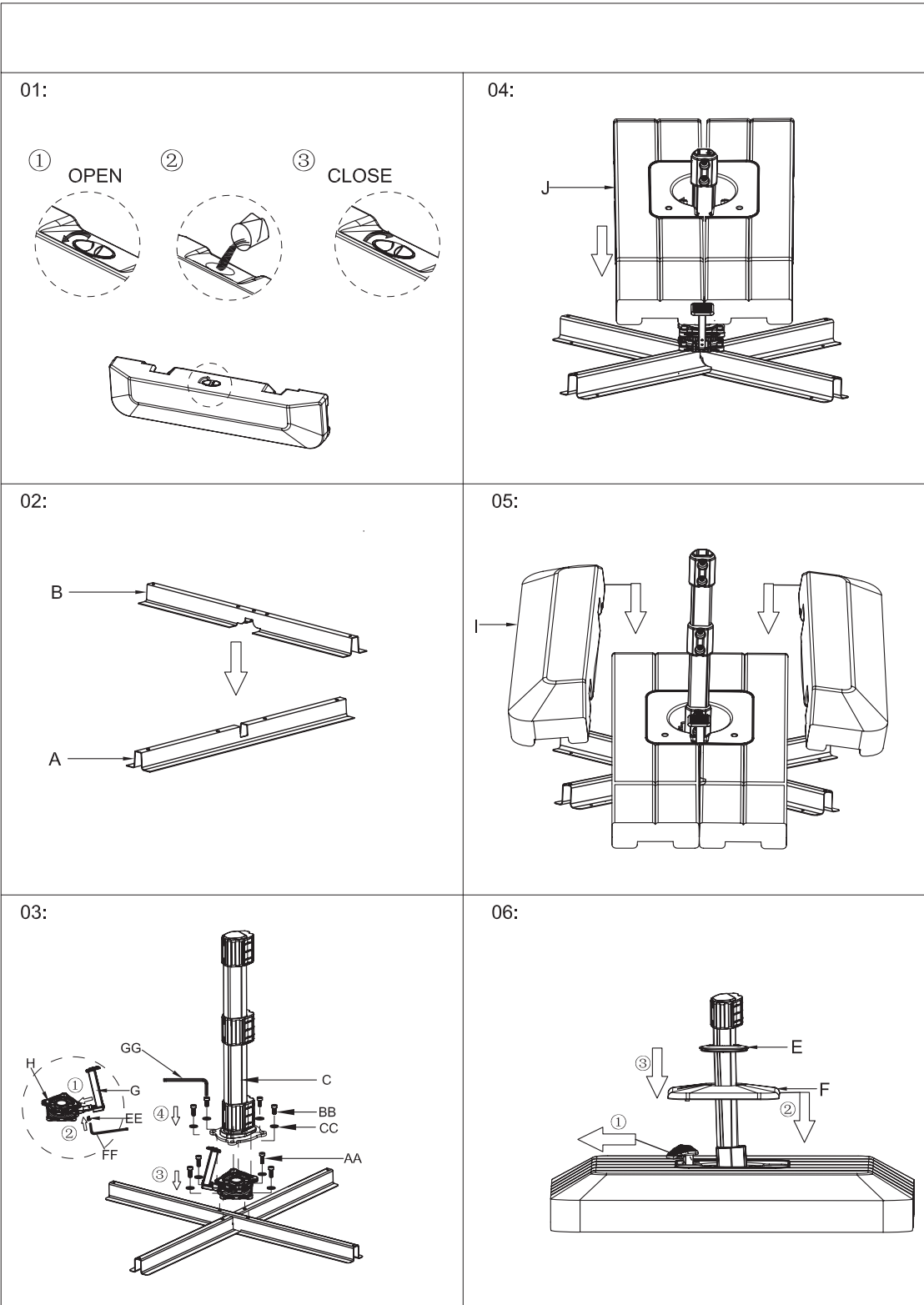

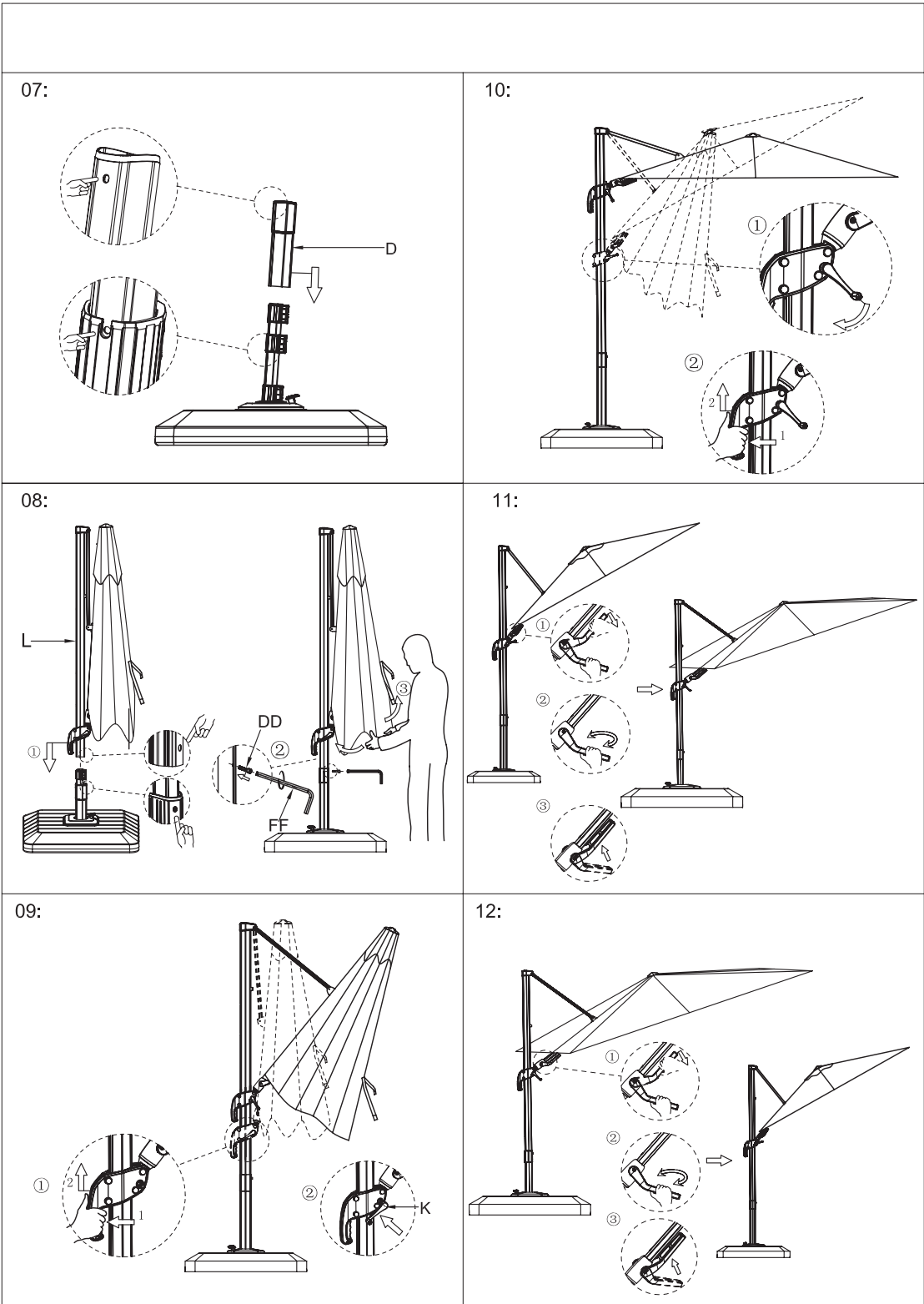

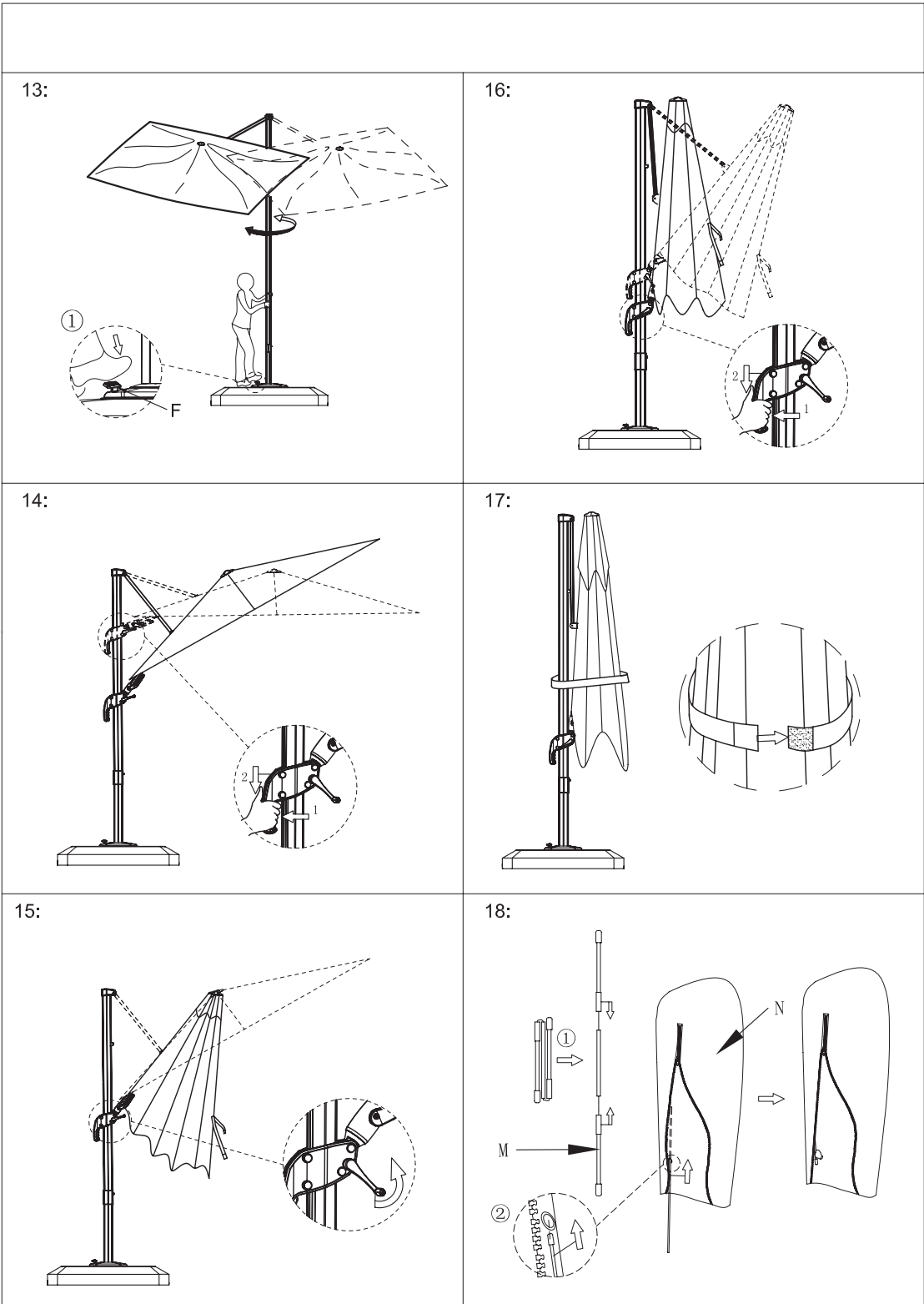

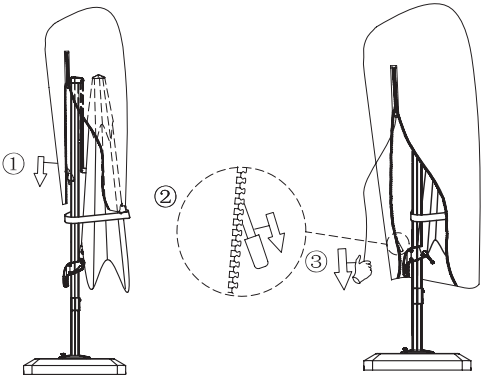
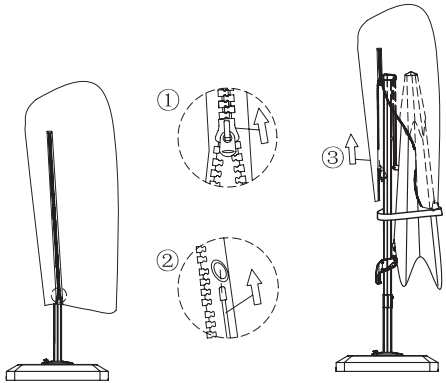
<p>19:</p> 	<p>16:</p>
<p>20:</p> 	

01:

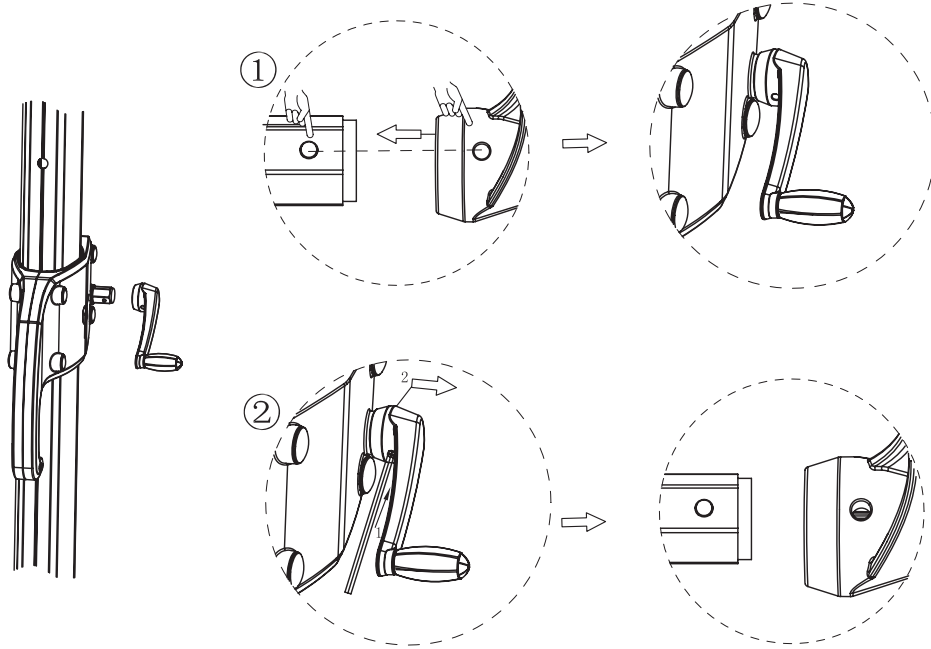

02:

