

GAVIA 90 ACERO MEPAMSA Acero Inox | 320.0528.014

FAMILY : Campanas | SERIE : GAVIA | MODEL : 90 ACERO MEPAMSA | FINISH : Acero Inox | INSTALLATION TYPE : Decorativa

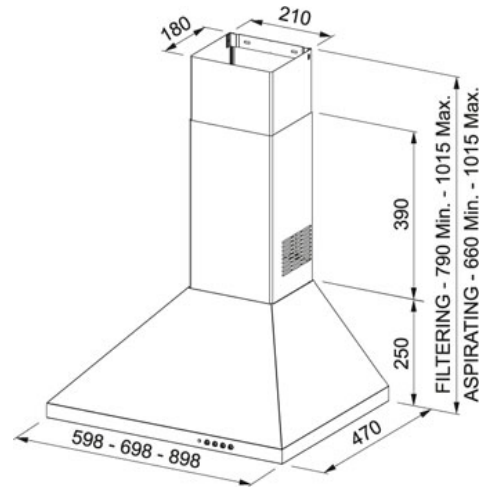

DATOS TÉCNICOS

Potencia Máx. (W)	250 W
Total Power	253 W
Iluminación	LEDS-2X1.5W
Aspiración en Mín. (UNE EN-61591)	320 m3/h
Aspiración en Máx. (UNE EN-61591)	650 m3/h
Aspiración en Int. (UNE EN-61591)	740-M3/H
Pot. Sonora en Mín. (UNE EN-60704-3)	53 dB(A)
Pot. Sonora en Máx. (UNE EN-60704-3)	68 dB(A)
Pot. sonora en Int. (UNE EN-60704-3)	71 dB(A)
Tipo de Mandos	Pulsantes
Ancho	90,00 cm
Tipo de campana	Isla
Clase Energética	B
Número de velocidades	3+int.
Salida	Ø-120---150-MM
Voltage	220-240V
Pressure	500,00 Pa
Grease filter	Filtros de Aluminio
Type of motor	Energy 900
Acabado	Acero Inoxidable
Dimensions	900X470