

Pantry-Küche (Dekor)

Montageanleitung / Notice de montage / Assembly instruction

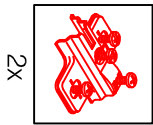

2x

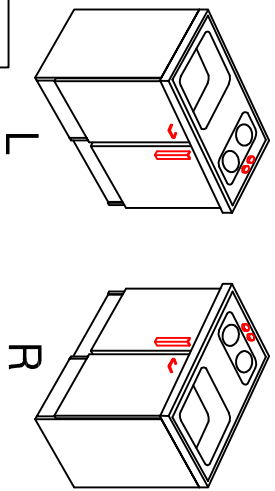
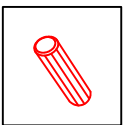
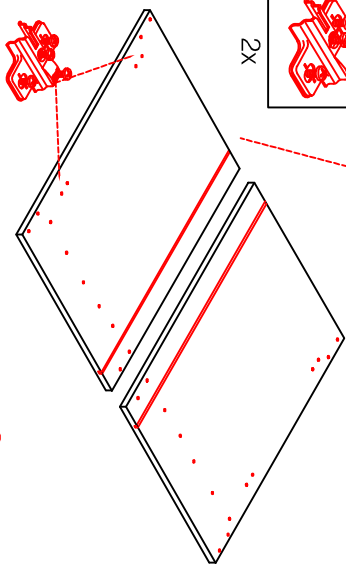

10x

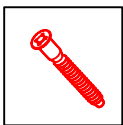
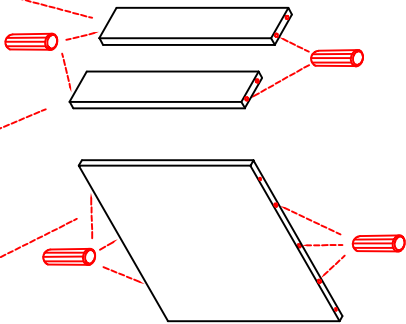

4x

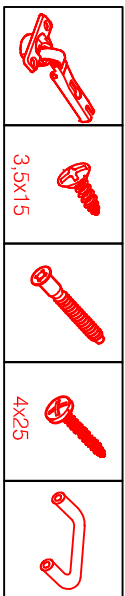
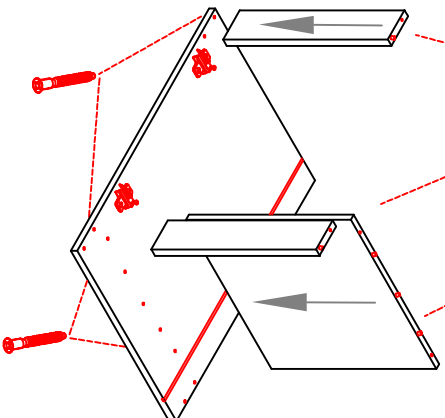

2x



4x

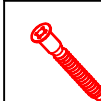

4x



2x



1x

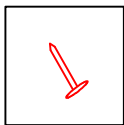

8x

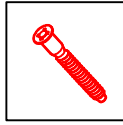
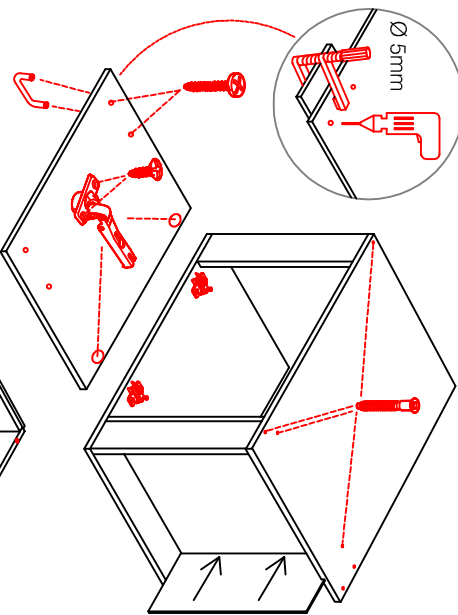
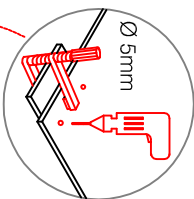

4x

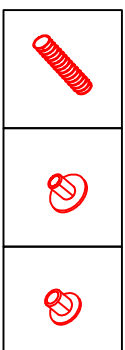
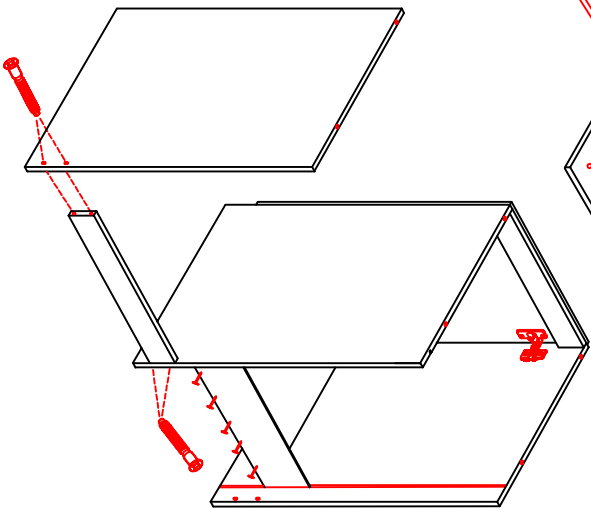

4x



8x



4x

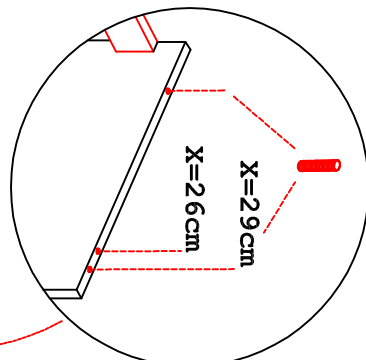
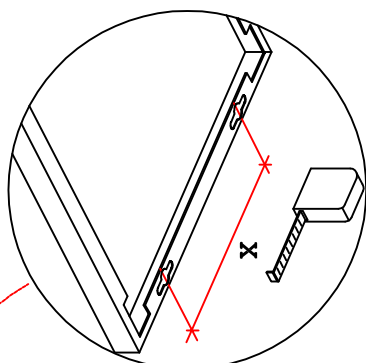

X=29 cm
X=26 cm

