

90 INOX V2 Acero Inox | 315.0486.088

FAMILY : Campanas | SERIE : SUPERLINE | MODEL : 90 INOX V2 | FINISH : Acero Inox | INSTALLATION TYPE : Cabinet

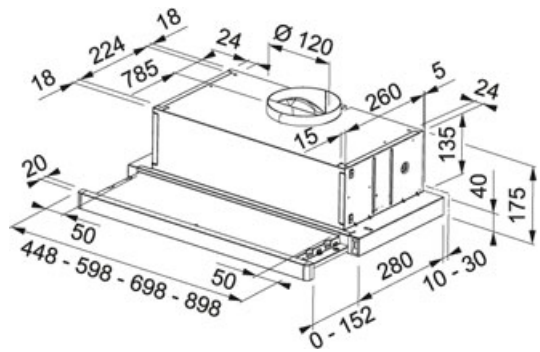

DATOS TÉCNICOS

Potencia Máx. (W)	140 W
Total Power	142-W
Iluminación	LEDS 2x1W
Aspiración en Mín. (UNE EN-61591)	235 m3/h
Aspiración en Máx. (UNE EN-61591)	415-M3/H
Pot. Sonora en Mín. (UNE EN-60704-3)	58-DBA
Pot. Sonora en Máx. (UNE EN-60704-3)	69 dB(A)
Tipo de Mandos	ELECTROMECHANICAL
Ancho	90,00 cm
Tipo de campana	CABINET
Clase Energética	D
Salida	Ø 120 mm
Voltage	220-240V
Pressure	240,00 Pa
Grease filter	Filtros de Aluminio
Type of motor	Energy 800
Acabado	Acero Inoxidable
Dimensions	900X280