

INSTALLATION MANUAL

- LAYING ON SCREED WITH GLUE
- LAYING ON WET SAND WITH CEMENT
- RAISED LAYING WITH SUPPORTS
- LAYING ON GRAVEL
- LAYING ON SAND
- LAYING ON GRASS



L'ALTRA[®] PIETRA

THE HIGH QUALITY
OUTDOOR PAVING

LAYING ON SCREED WITH ADHESIVE

The advanced technical features of the 2 cm (3/4")-thick L'Altra Pietra collections, combined with an adhesive laying technique on screed, allow users to create perfectly stable and exceptionally hard-wearing surfaces. L'Altra Pietra slabs used with this solution can withstand both moving and parked vehicles. Ideal for heavily frequented areas, in particular for squares, pavements, or ramps.

ADVANTAGES:

- Maximum stability over time
- Ideal for areas open to vehicle traffic
- Ideal for areas frequented by large numbers of pedestrians

INTENDED USE:

- Driveways
- Pool sides
- Terraces
- Car parking
- Residential areas
- Commercial areas
- Outdoor stairs
- Garage ramps



DRIVE-OVER

Expansion joints are necessary and joints must be filled with cementitious grout.



INSTALLATION

EXAMPLE OF LAYING ON GROUND

- A L'ALTRA PIETRA[®] slabs
- B Concrete screed (may include electro welded mesh)
- C Reinforcement layer
- D Concrete screed
- E Loose stone foundation (gravel)
- F Soil

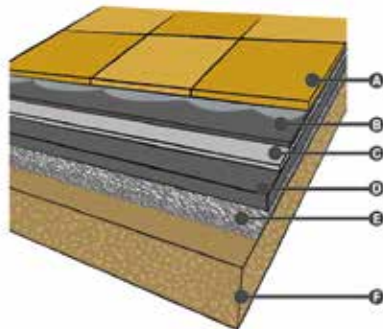

EXAMPLE OF LAYING ON FLAT COVERING

- A L'ALTRA PIETRA[®] slabs
- B Concrete screed
- C Separation layer
- D Thermal insulation element
- E Vapour barrier
- F Waterproof layer
- G Sloping screed
- H Floor

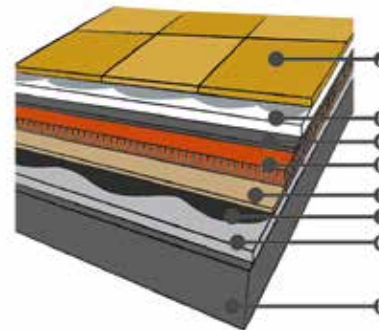

WHAT YOU NEED:

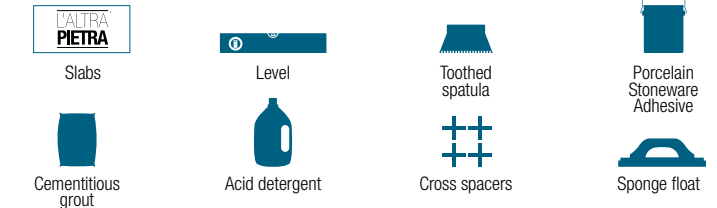

INSTRUCTIONS:

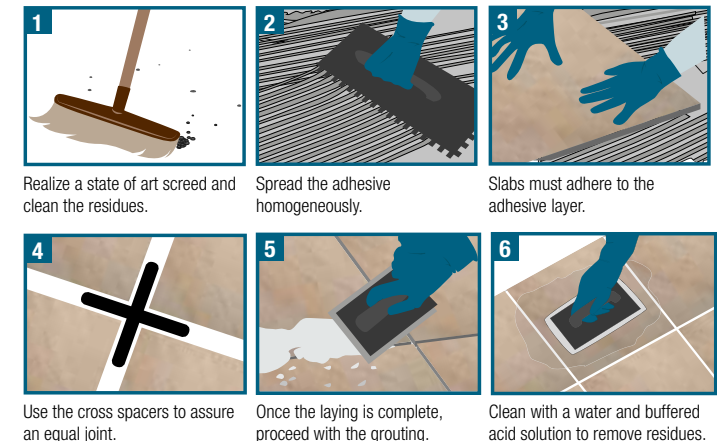

The proposed diagrams and indications are purely indicative of the type of application: please refer to the specific regulations in force in your country in order to lay the floor to the highest technical standards.

LAYING ON WET SAND WITH CEMENT

The slabs are laid on a base of sand mixed with cement. This technique guarantees the slabs long term stability and their vehicle accessibility. It also allows to lay the slabs straight on the floor screed avoiding the high costs of the levelling screed arrangements.



ADVANTAGES:

- Maximum stability over time
- Ideal for areas open to vehicle traffic
- Ideal for areas frequented by large numbers of pedestrians

INTENDED USE:

- Driveways
- Pool sides
- Terraces
- Car parking
- Residential areas
- Commercial areas
- Outdoor stairs
- Garage ramps



DRIVE-OVER

Expansion joints are necessary and joints must be filled with cementitious grout.

WHAT YOU NEED:



INSTRUCTIONS:

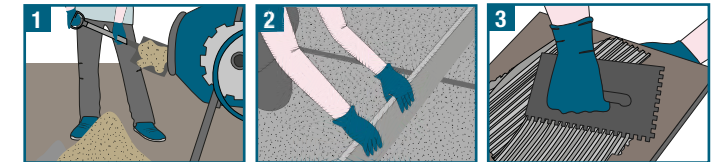

1 Prepare the mixture of sand and cement in the concrete mixer, two parts of cement by weight per ten parts of sand. Cement and water in equal parts.

2 Lay the mixture over the existing screed and level it guaranteeing a slope of at least 2%. The layer thickness must be between 5 to 7 cm (2" - 3") to guarantee drive-over.

3 Spread the adhesive for porcelain stoneware on the back of the slabs.

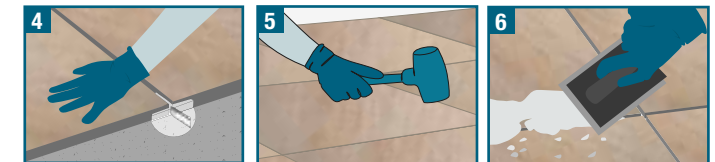

4 Lay the slabs with the aid of the Crocette cross spacers.

5 Use the rubber mallet to level the slabs.

6 Once the laying is complete, proceed with the grouting.

INSTALLATION

EXAMPLE OF LAYING ON SCREED

- A L'ALTRA PIETRA[®] slabs
- B Adhesive for porcelain stoneware
- C Sand with cement levelling screed
- D Floor screed

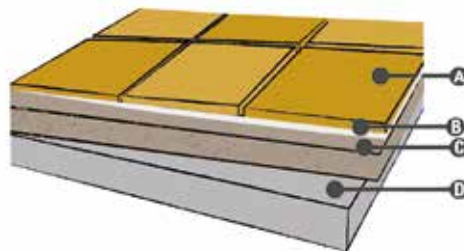

L'ALTRA PIETRA[®]

THE HIGH QUALITY
OUTDOOR PAVING

RAISED LAYING WITH SUPPORT

Floating paving is composed by a series of modular and adjustable supports, that easily and safely adapt to all paving types. Designed to guarantee an homogeneous surface, without bringing radical changes to the existing structure, as well as to eliminate humidity problems, water infiltrations, passage of electric cables and pipes, floating paving solutions allow easy and quick inspections and rainwater efficient drainage.

INTENDED USE:

- Residential areas
- Commercial areas
- Terraces
- Garden, courtyard or patio

INSTALLATION

EXAMPLE OF RAISED LAYING

- A L'ALTRA PIETRA[®] slabs
- B Adjustable/fixed supports
- C Waterproof sheath
- D Screed with maximum slope of 5%

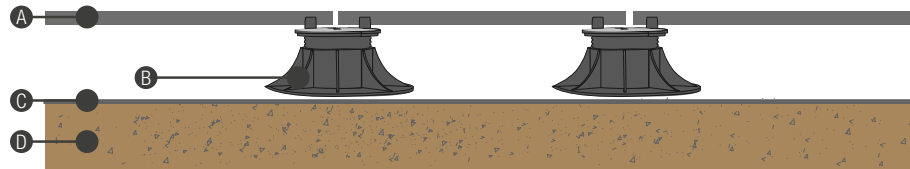

LAYING ADVISE

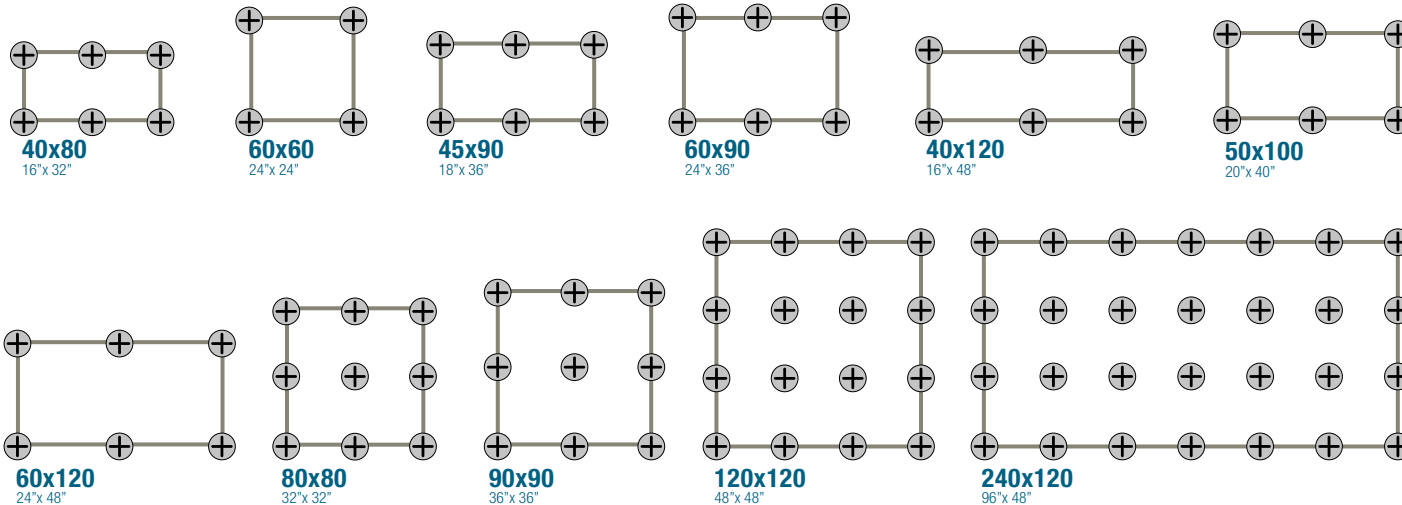

The proposed diagrams and indications are purely indicative of the type of application: please refer to the specific regulations in force in your country in order to lay the floor to the highest technical standards.



WHAT YOU NEED:



INSTRUCTIONS:



1 Realize a state of art screed and clean the residues.



2 Place the supports in relation to the dimensions of the used tile.

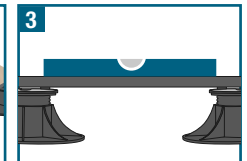

3 Verify the proper levelling of the laid slabs (slope ≥ 1%).

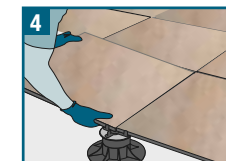

4 When laying, check that the joint width is always constant.

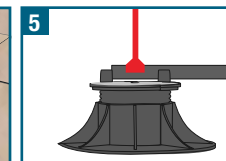

5 Finished the laying, adjust the supports height with the adjusting key.

LAYING ON GRAVEL

This system is particularly recommended in areas where drainage of the water in the underlying soil is a problem, and also for concrete floor screeds, such as on balconies or terraces. The slabs can be laid dry by simply placing them on top of the previously prepared gravel base, without the need of porcelain stoneware adhesives. This means the slabs are easily levelled out on top of the gravel and are ready for use immediately afterwards.

INTENDED USE:

- Residential areas
- Footpaths
- Terraces
- Garden, courtyard or patio

INSTALLATION

EXAMPLE OF LAYING ON GROUND

- A L'ALTRA PIETRA[®] slabs
- B Gravel
- C Non-woven fabric
- D Drainage layer
- E Soil

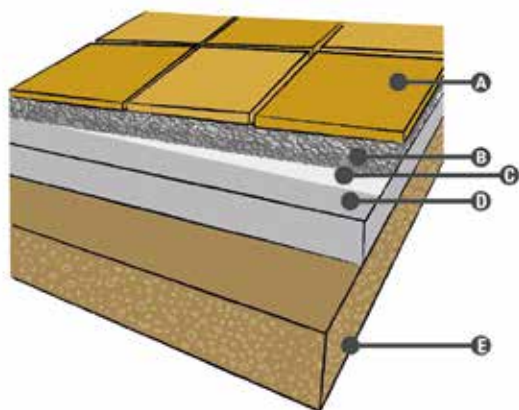

EXAMPLE OF LAYING ON FLAT COVERING

- A L'ALTRA PIETRA[®] slabs
- B Ballast layer of gravel
- C Separation layer
- D Thermal insulation element
- E Vapour barrier
- F Waterproof layer
- G Sloping screed
- H Floor

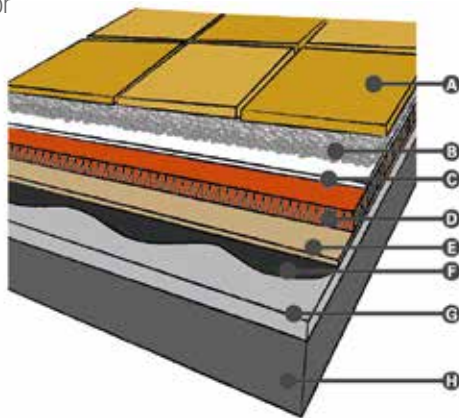

The proposed diagrams and indications are purely indicative of the type of application: please refer to the specific regulations in force in your country in order to lay the floor to the highest technical standards.



WHAT YOU NEED:

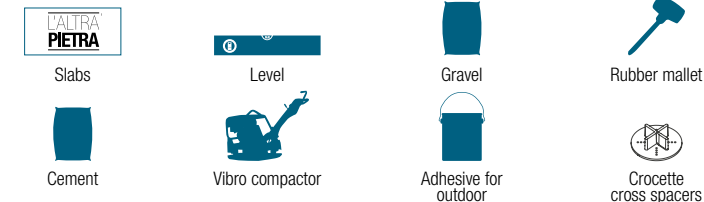

INSTRUCTIONS:

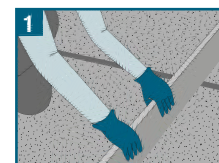

Over the non-woven fabric or the separation layer, lay the gravel (10/30 cm 4"-12"). To give more stability can be added a binder.

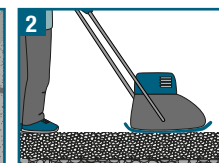

Level the soil with the aid of a vibro compactor, to guarantee stability over the time. A slope of at least 2% is needed to ensure the right water drainage.

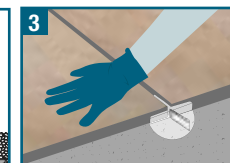

Lay the slabs with the aid of the Crocette cross spacers.

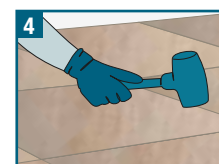

Use the rubber mallet to level the slabs.



Once the laying is complete, proceed with the grouting.

L'ALTRA[®] PIETRA

THE HIGH QUALITY
OUTDOOR PAVING

LAYING ON SAND

The slabs can be laid dry by simply placing them in the desired position, without the need adhesives. This means the slabs are easily levelled out on top of the sand and are ready for use immediately afterwards. This allows users to change the paving at any time or reuse the same material several times, even in different locations.

INTENDED USE:

- Residential areas
- Footpaths
- Terraces
- Garden, courtyard or patio

INSTALLATION

EXAMPLE OF LAYING ON GROUND

- A L'ALTRA PIETRA[®] slabs
- B Sand
- C Non-woven fabric
- D Drainage layer
- E Soil

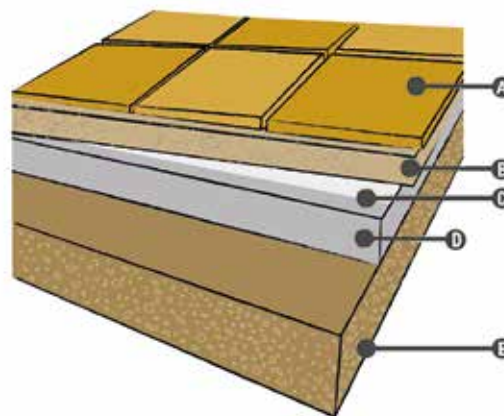

WHAT YOU NEED:

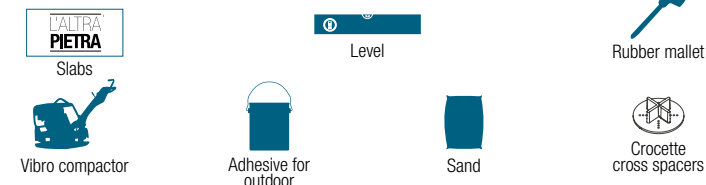

INSTRUCTIONS:

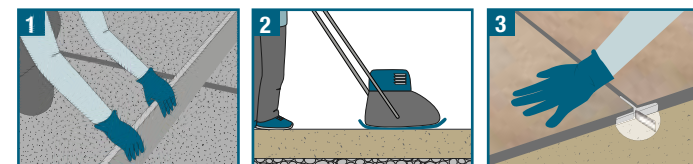

Over the non-woven fabric lay the gravel (2-5 cm 1"-2"). A slope of at least 2% is needed to ensure the right water drainage.

Level the soil with the aid of a vibro compactor, to guarantee stability over the time.

Lay the slabs with the aid of the Crocette cross spacers.



Use the rubber mallet to level the slabs.

Once the laying is complete, proceed with the grouting.

INSTRUCTIONS:

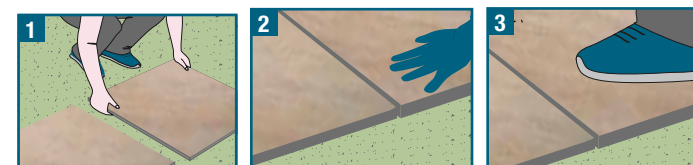

Arrange the slabs on the ground to define the correct positioning and the preferred distance.

Make sure the distance between the slabs is the same.

Step on the slabs, insisting on the edges to match them well to the ground.

LAYING ON GRASS

Where there are lawns slabs can be dry laid on top of grass without using any adhesives. This allows users to change the paving at any time and reuse the same material several times.

Dry-laying does not require specialized installers and the slabs are ready for use as soon as the job is finished.

INTENDED USE:

- Residential areas
- Footpaths
- Gazebo
- Garden, courtyard or patio



The proposed diagrams and indications are purely indicative of the type of application; please refer to the specific regulations in force in your country in order to lay the floor to the highest technical standards.

L'ALTRA[®]
PIETRA

THE HIGH QUALITY
OUTDOOR PAVING

WWW.ALTRAPIETRA.IT