

Manual de Montaje

Manual de Montagem

Installation Manual

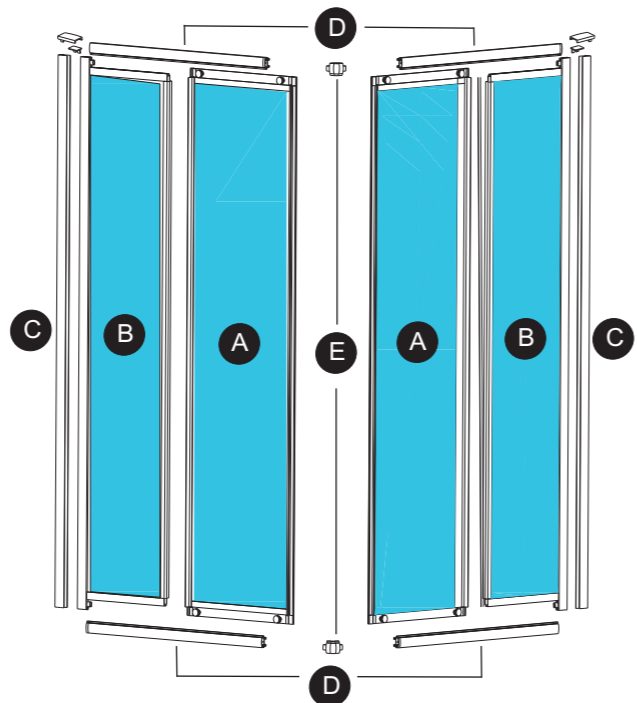
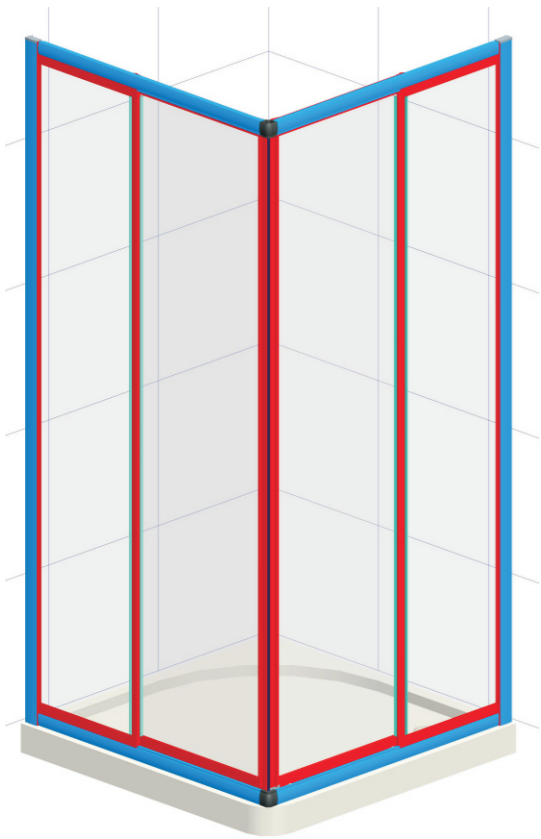

- A.- Puerta corredera ×2
- B.- Puerta fija ×2
- C.- Perfil compensación ×2
- D.- Guia corredera ×4
- E.- Codo de unión ×2

1

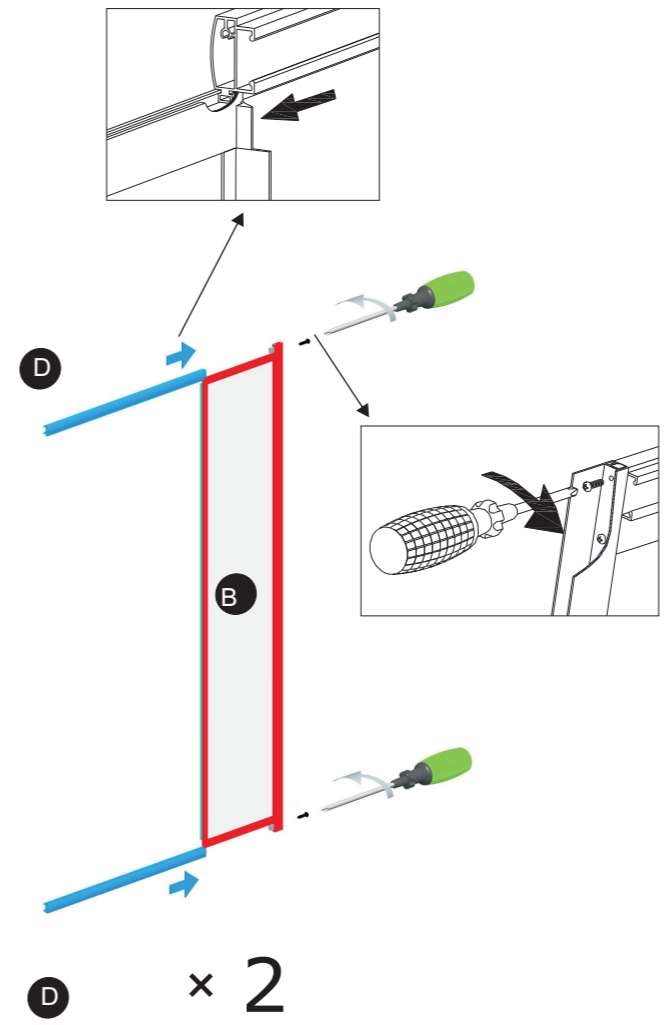

2

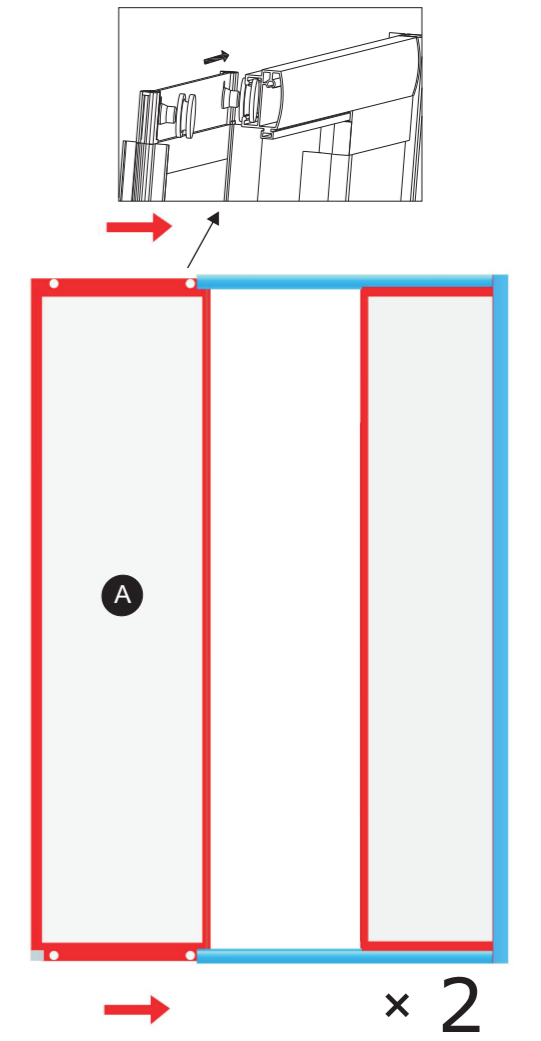

3

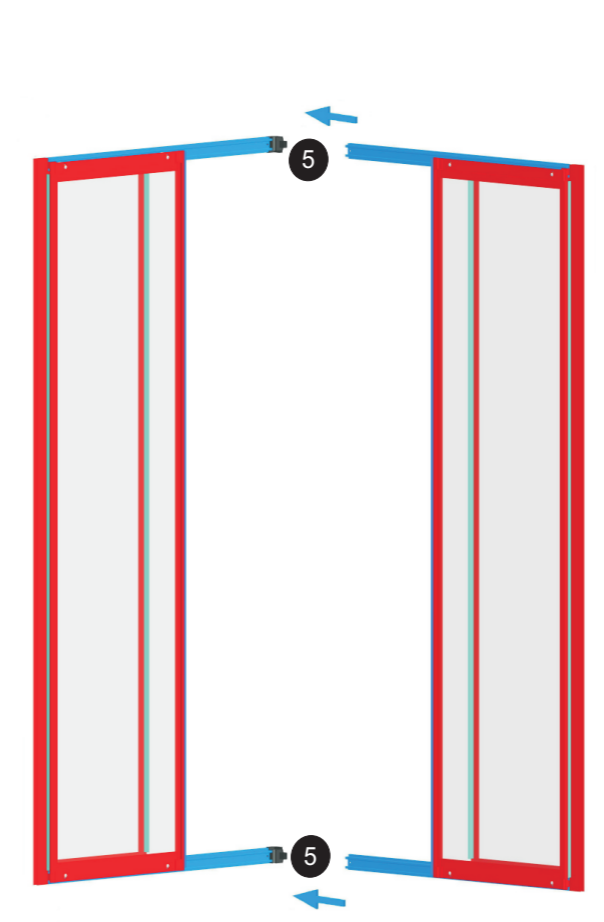

4

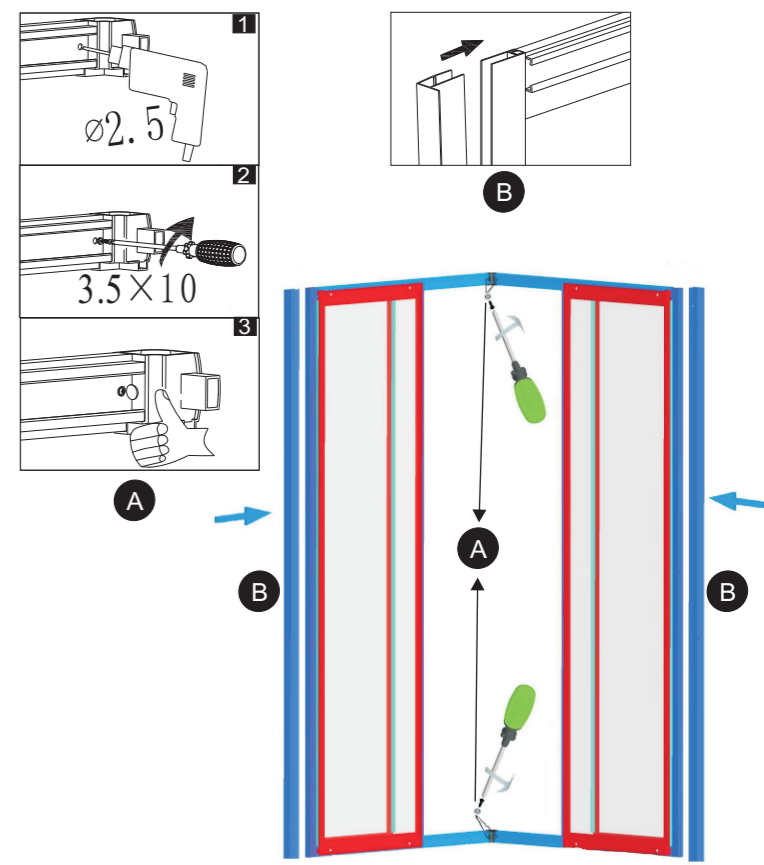

Continuación
Continue

Accesorios

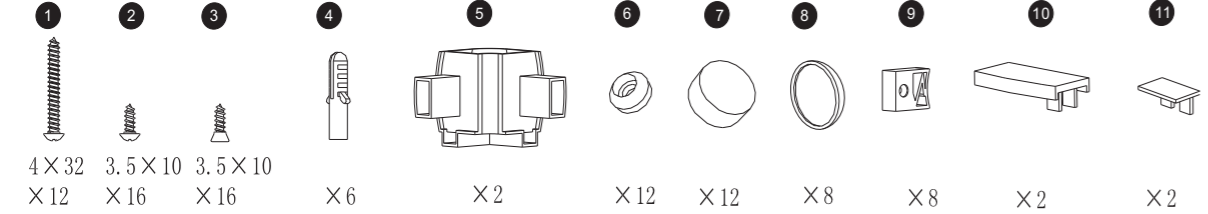

- 1 Tornillo 4×32 ×12
- 2 Tornillo 3.5×10 ×16
- 3 Tornillo 3.5×10 ×16
- 4 Taco ×6
- 5 Codo unión ×2
- 6 Anillo de tap ×12
- 7 Tapón redondo ×12
- 8 Tapón ruedas ×8
- 9 Topes de rueda ×8
- 10 Tapa perfil ×2
- 11 Prolongación tapa perfil ×2

Herramientas

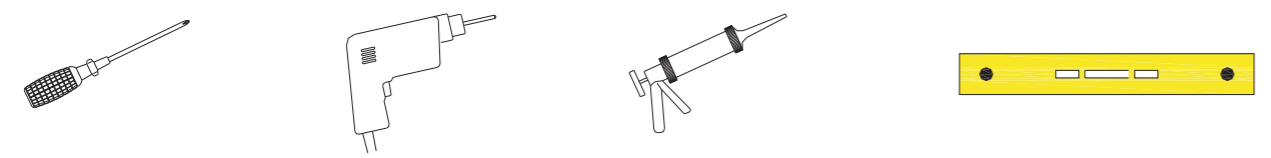

Ø 2.5 para metal
Ø 6 para pared

