

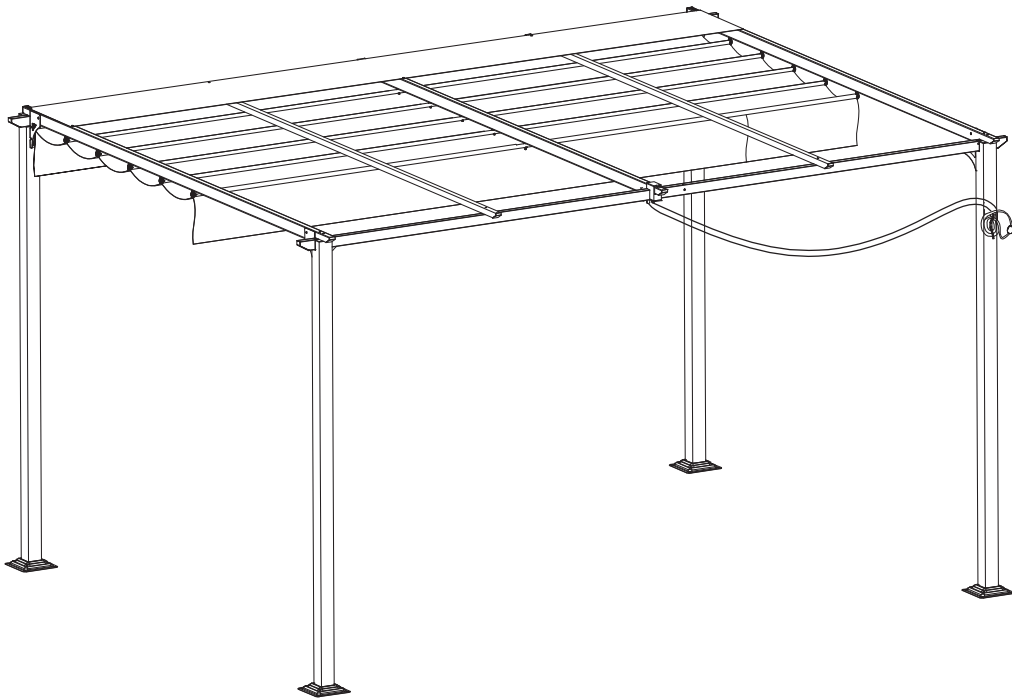

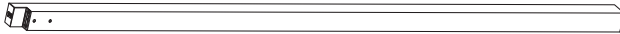

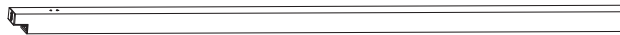













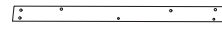







GFM01108K



A	3				
B	1				
C	1				
C1	2				
D	1				
E	2				
F	1				
G	2				
H	6				
I	6				
J	1		K	1	
L	4		M	1	
N	1		O	2	 M5 *12mm
P	30+2	 M6 *15mm	Q	8+1	 M6 *20mm
R	12+1	 M6 *18mm	S	16+2	 M6 *45mm
T	8+1	 M6 *70mm	V	4	 M6
W1	2		W2	2	
X	16		Y	2	
Z	1				

STEP 01

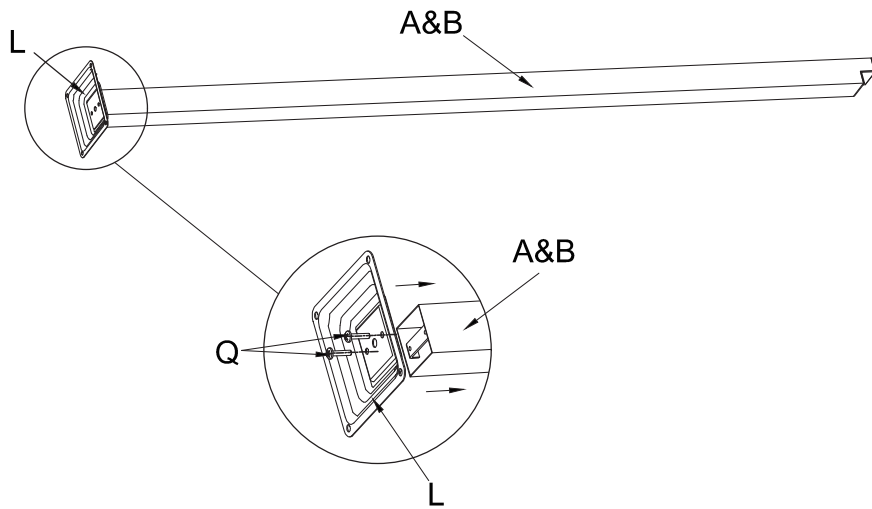

STEP 02

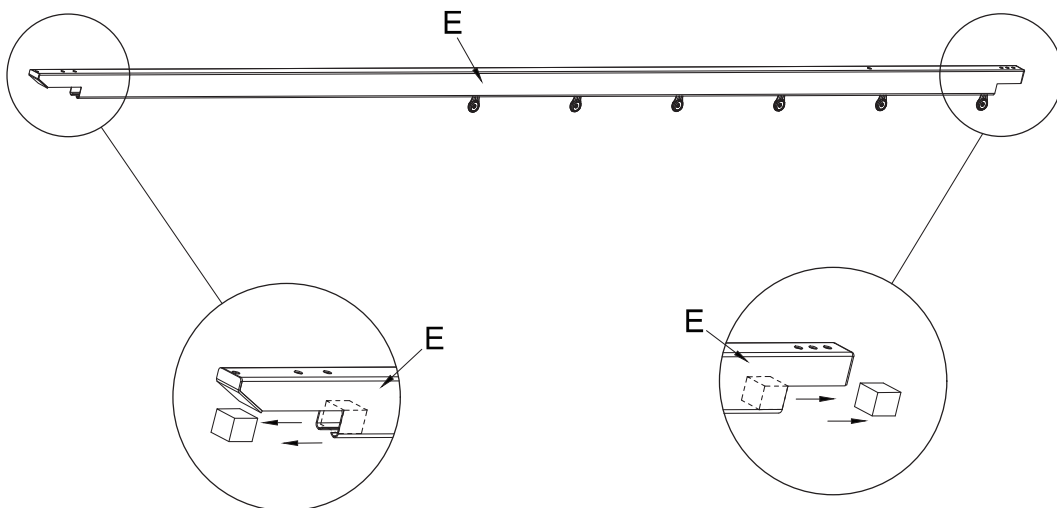

STEP 03

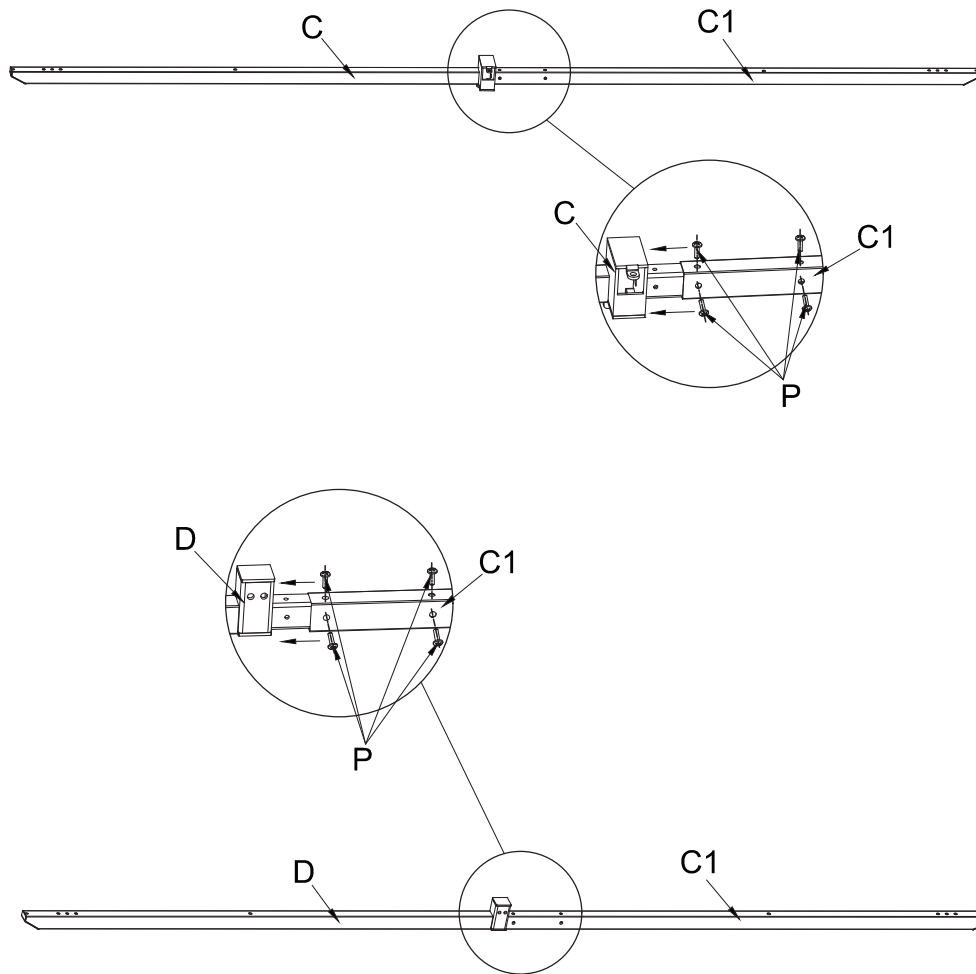

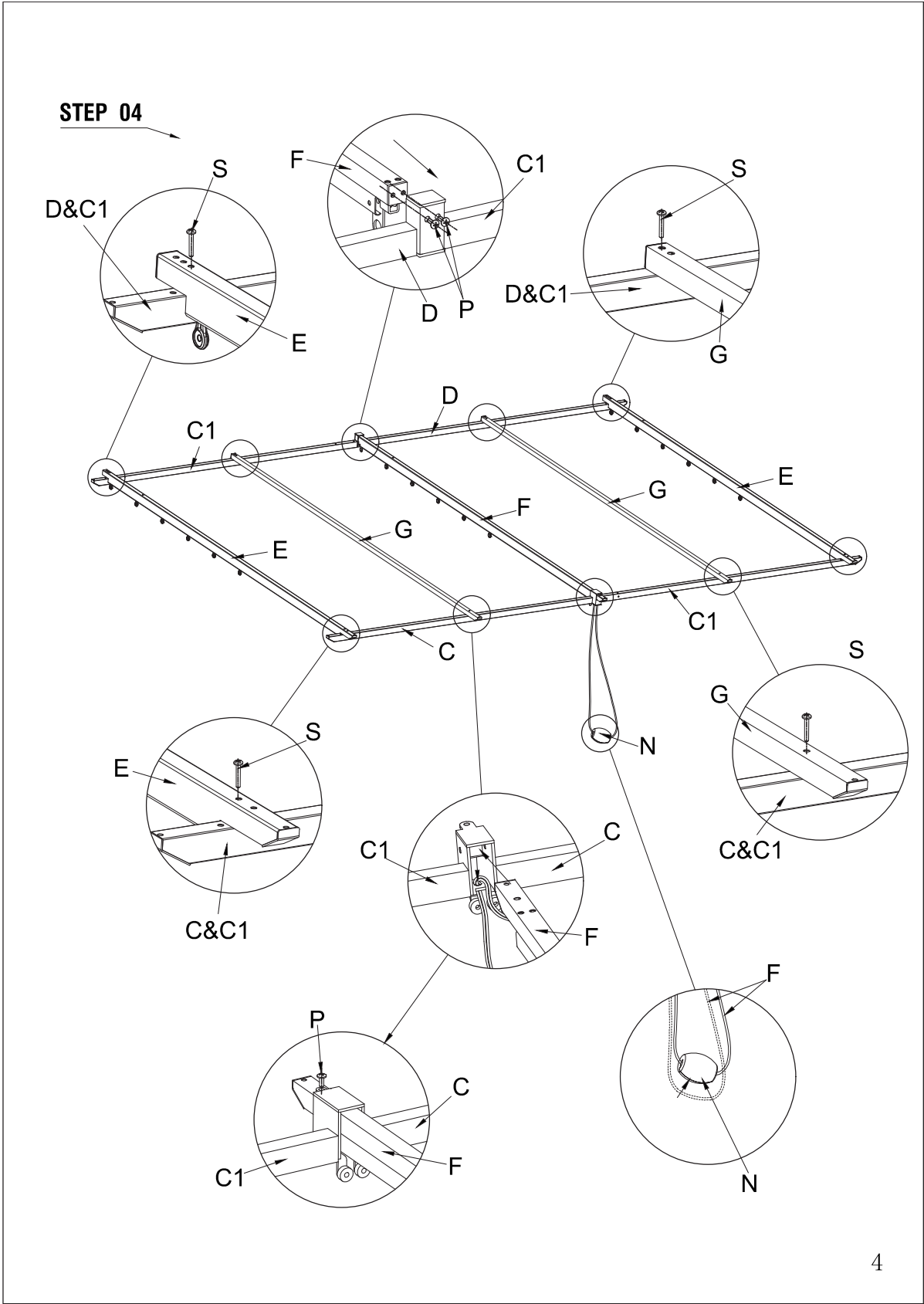

STEP 05

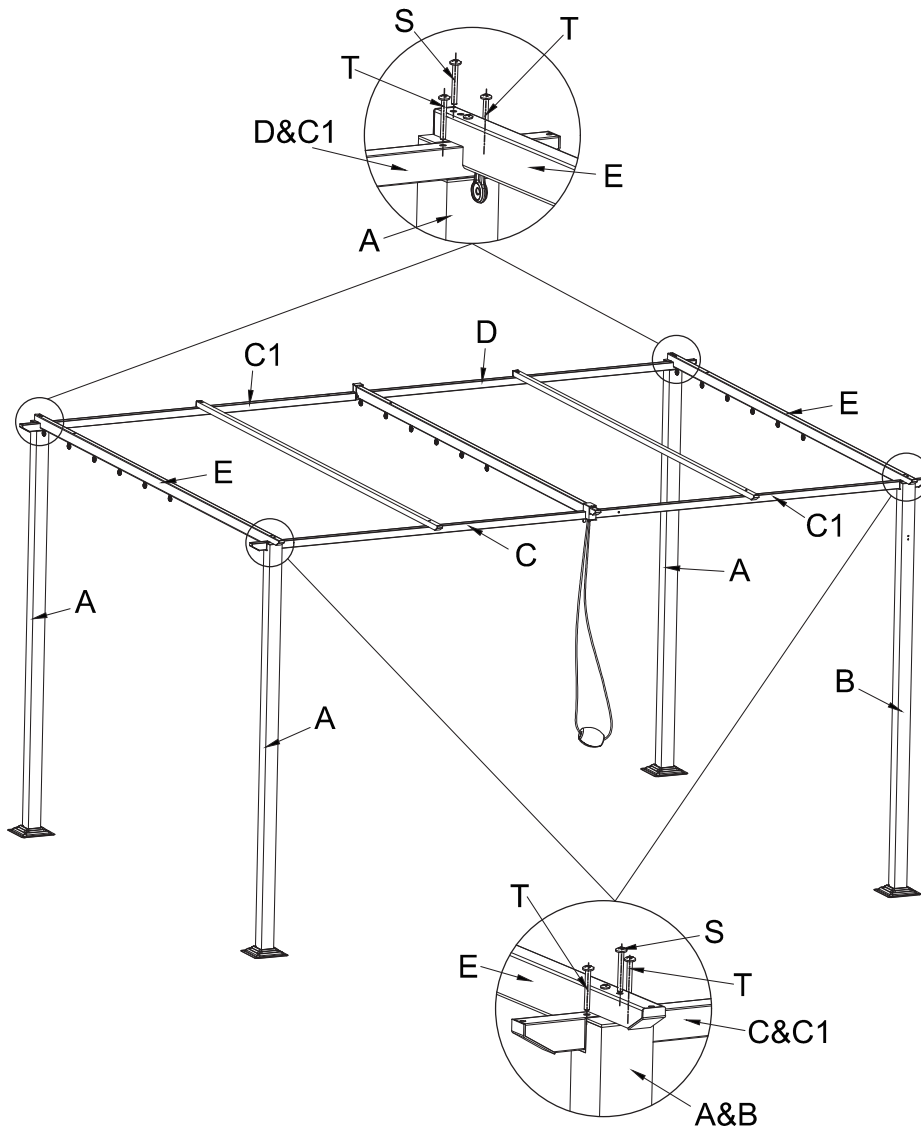

STEP 06

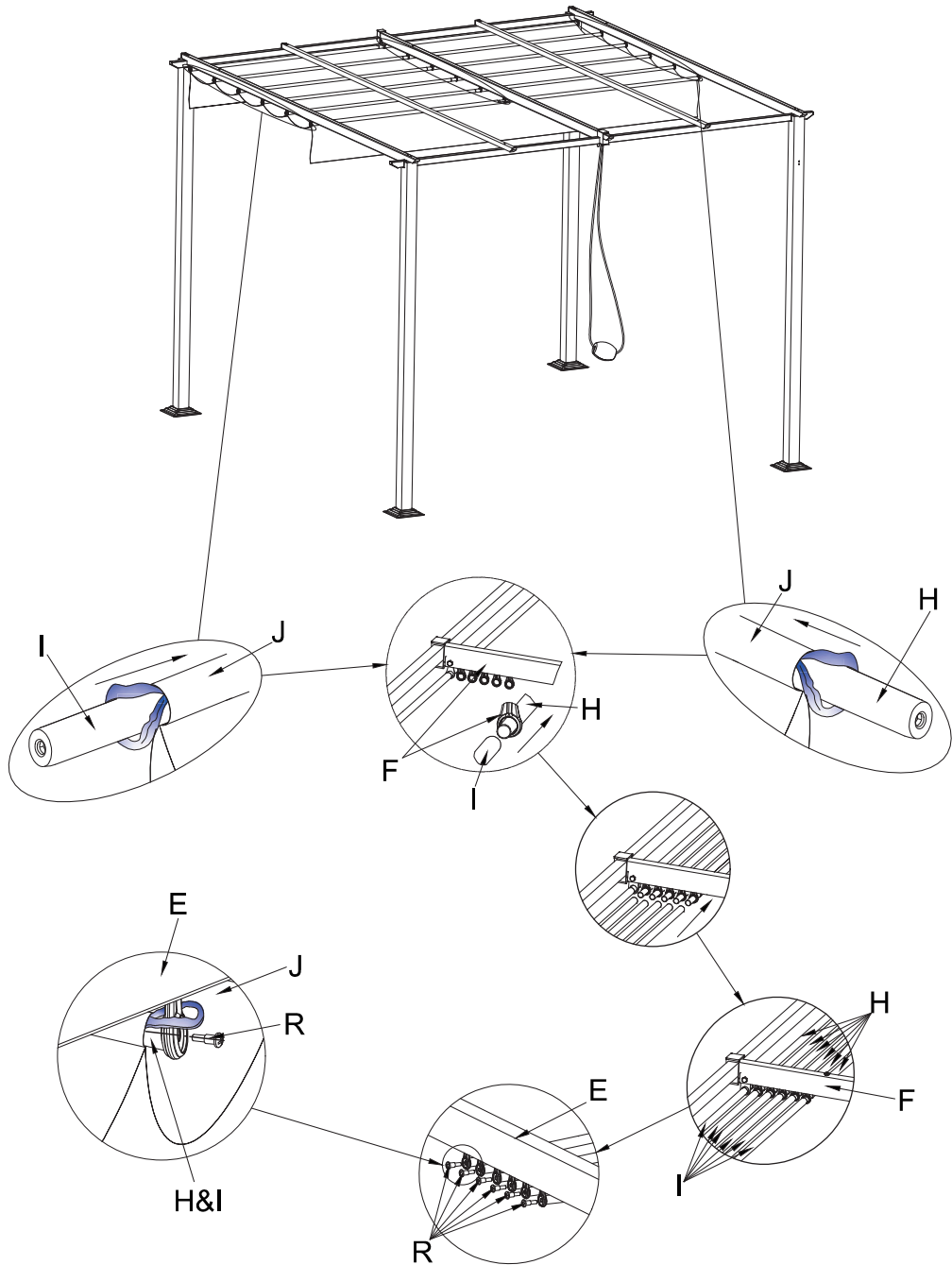

STEP 07

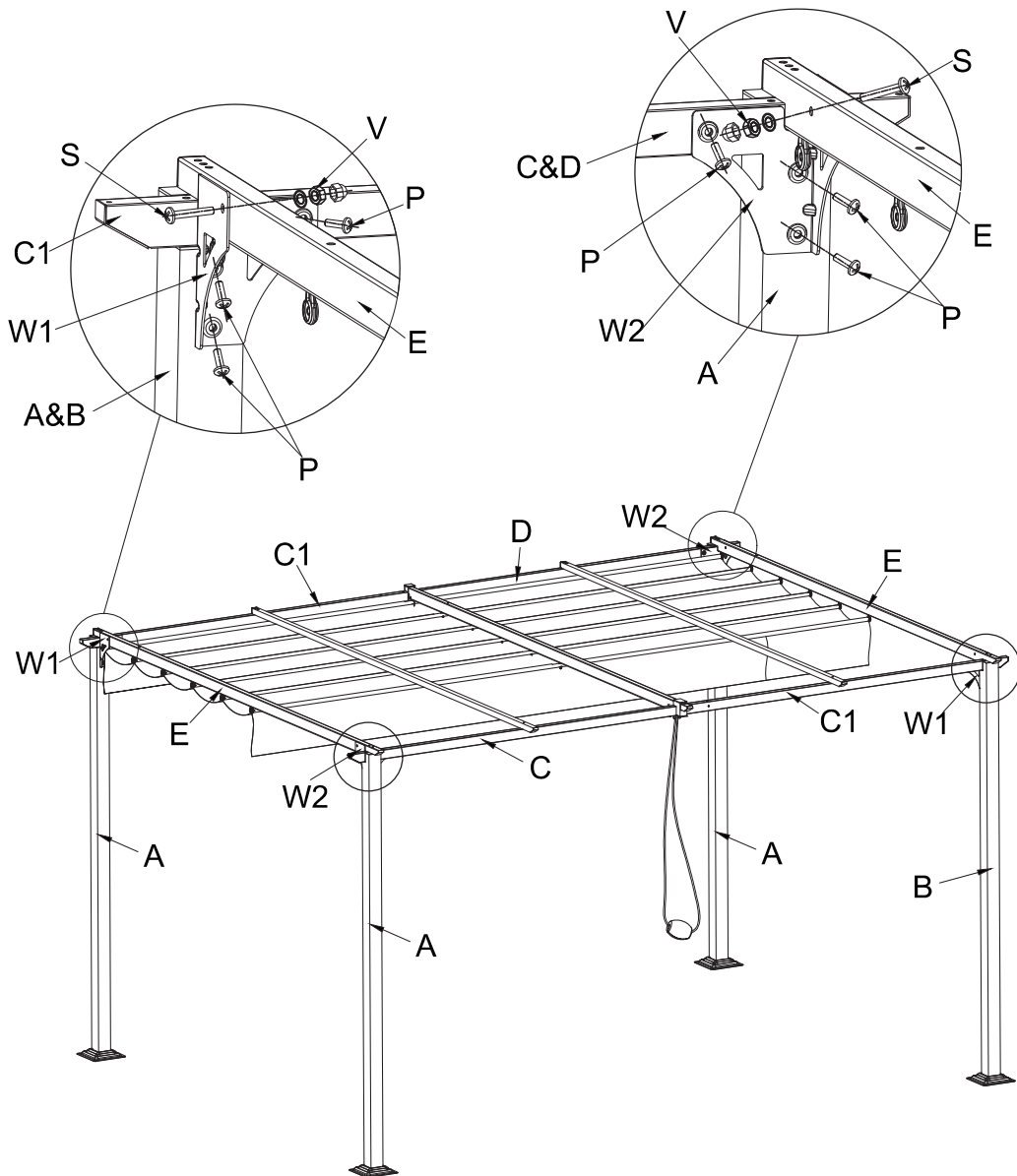

STEP 08

