

2257

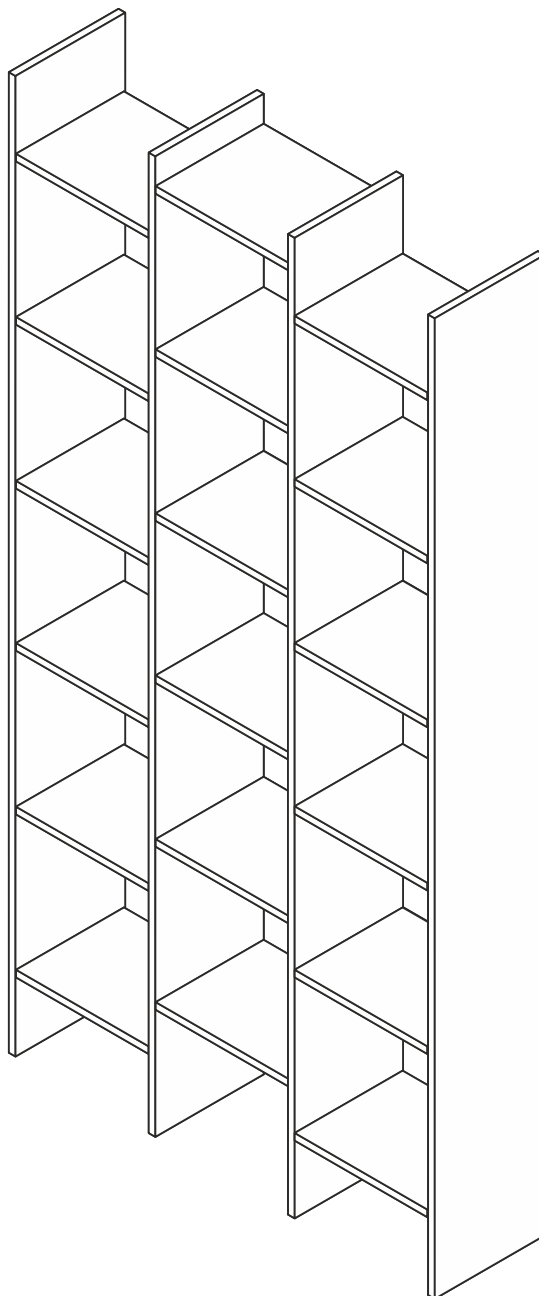

**ESTANTERÍA - BOOKCASE - ÉTAGÈRE - PRATELEIRA -
SCAFFALE - BÜCHERGESTELL - ΡΑΦΙΕΡΑ**

INSTRUCCIONES DE MONTAJE - ASSEMBLING INSTRUCTIONS - NOTICE DE MONTAGE - INSTRUÇÕES DE MONTAGEM -
ISTRUZIONI DI MONTAGGIO - MONTAGEANLEITUNG - ΟΔΗΓΙΕΣ ΣΥΝΑΡΜΟΛΟΓΗΣΗΣ

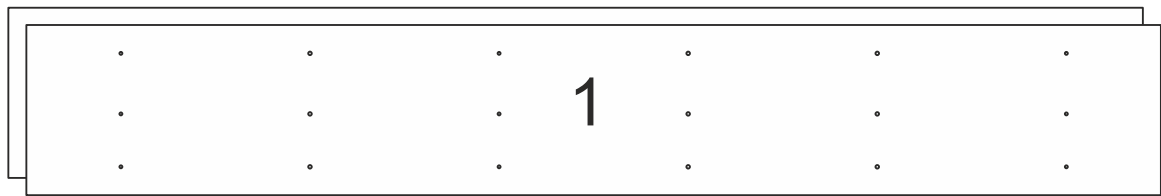
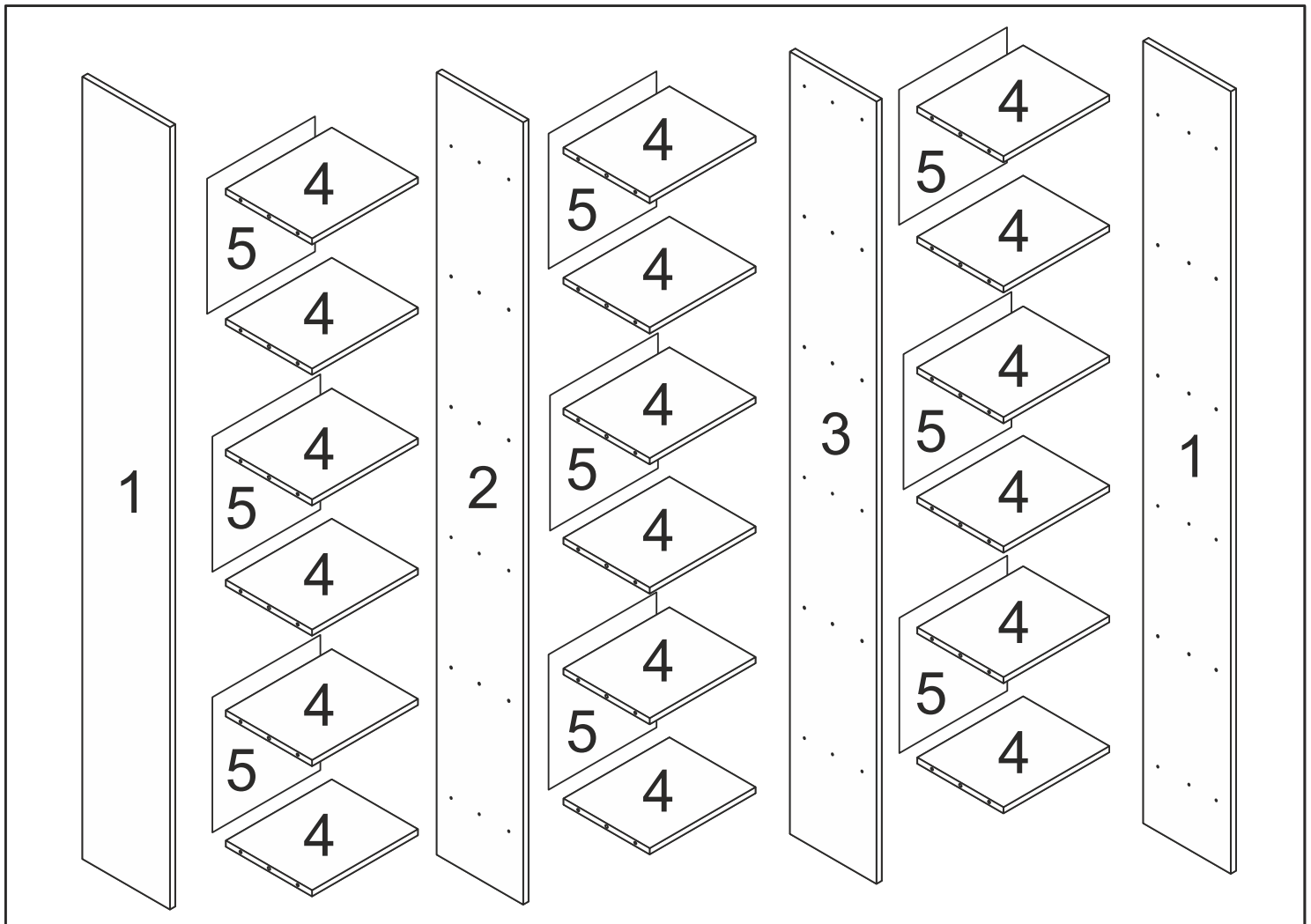

1920 x 248 mm



1920 x 245 mm



1920 x 245 mm

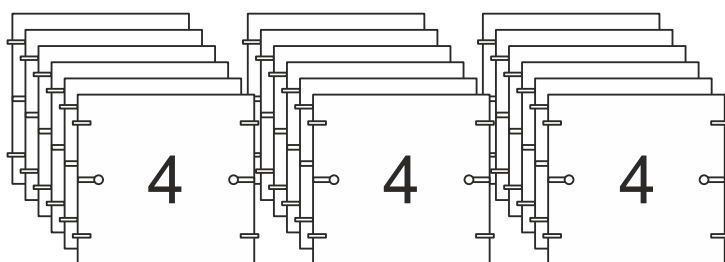

300 x 244 mm



332 x 306 mm

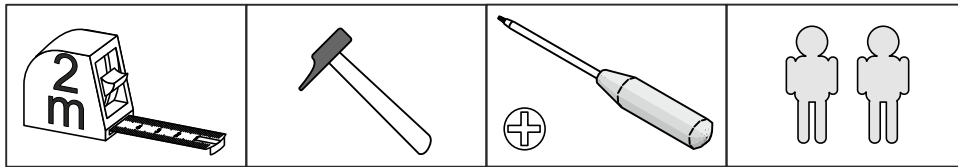

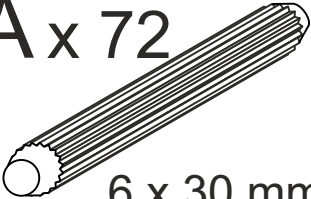
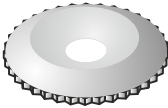
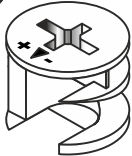
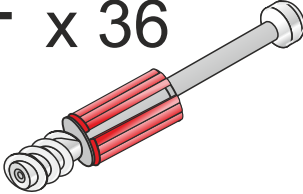
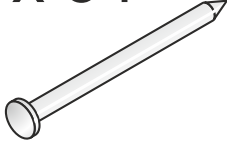
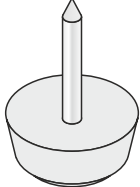
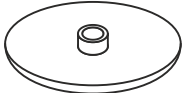
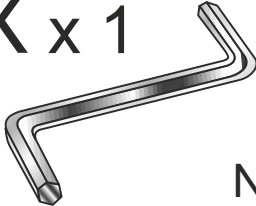
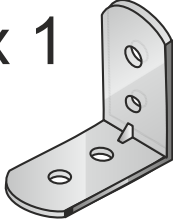
| | | |
|---|--|---|
| <p>A x 72</p>  <p>6 x 30 mm</p> | <p>D x 6</p>  | <p>E x 36</p>  |
| <p>F x 36</p>  | <p>N x 54</p>  | <p>P x 8</p>  |
| <p>V x 36</p>  <p>15 mm</p> | <p>X x 1</p>  <p>N°4</p> | <p>Z x 1</p>  |

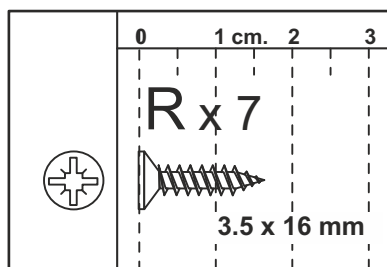

1

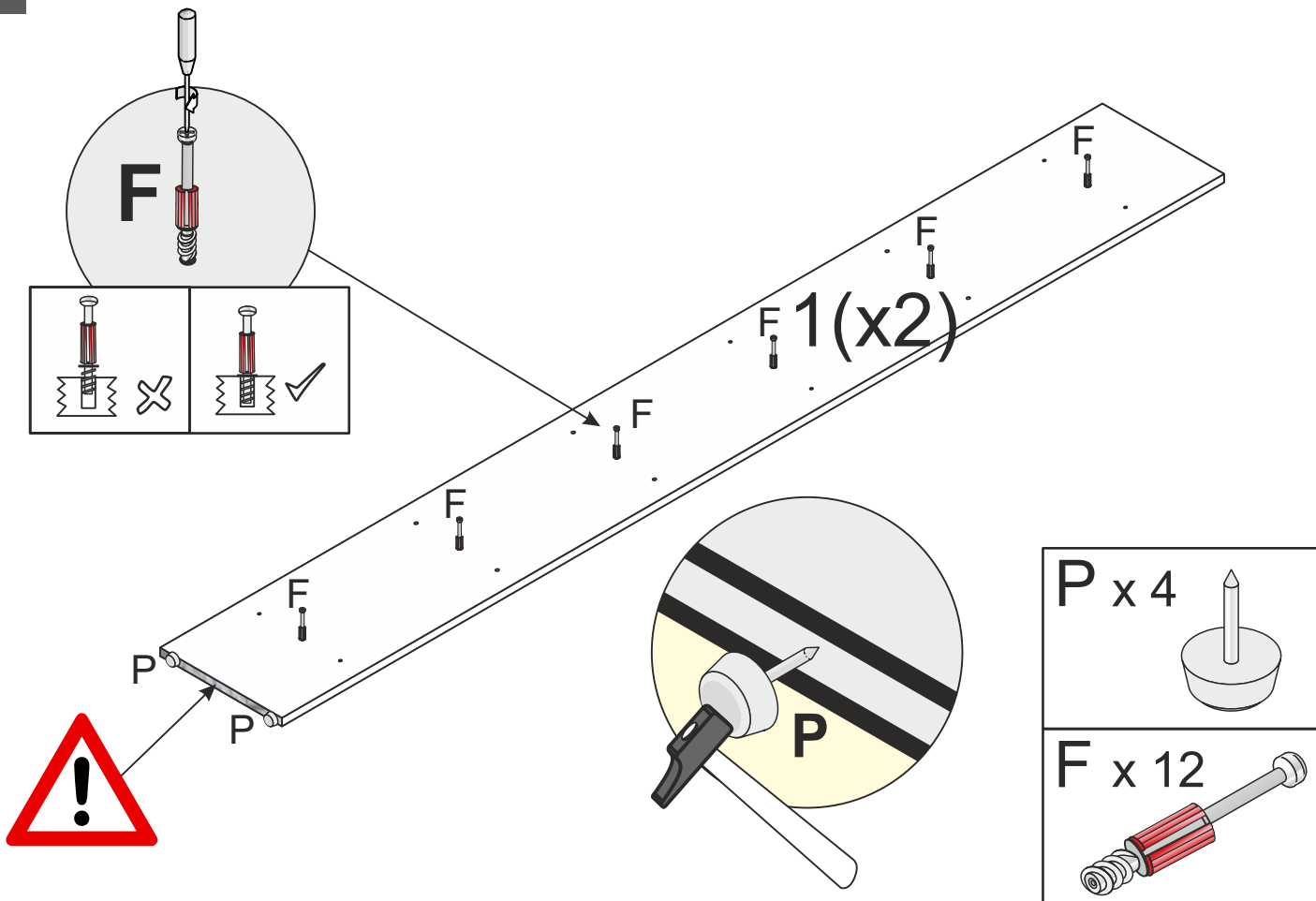

2

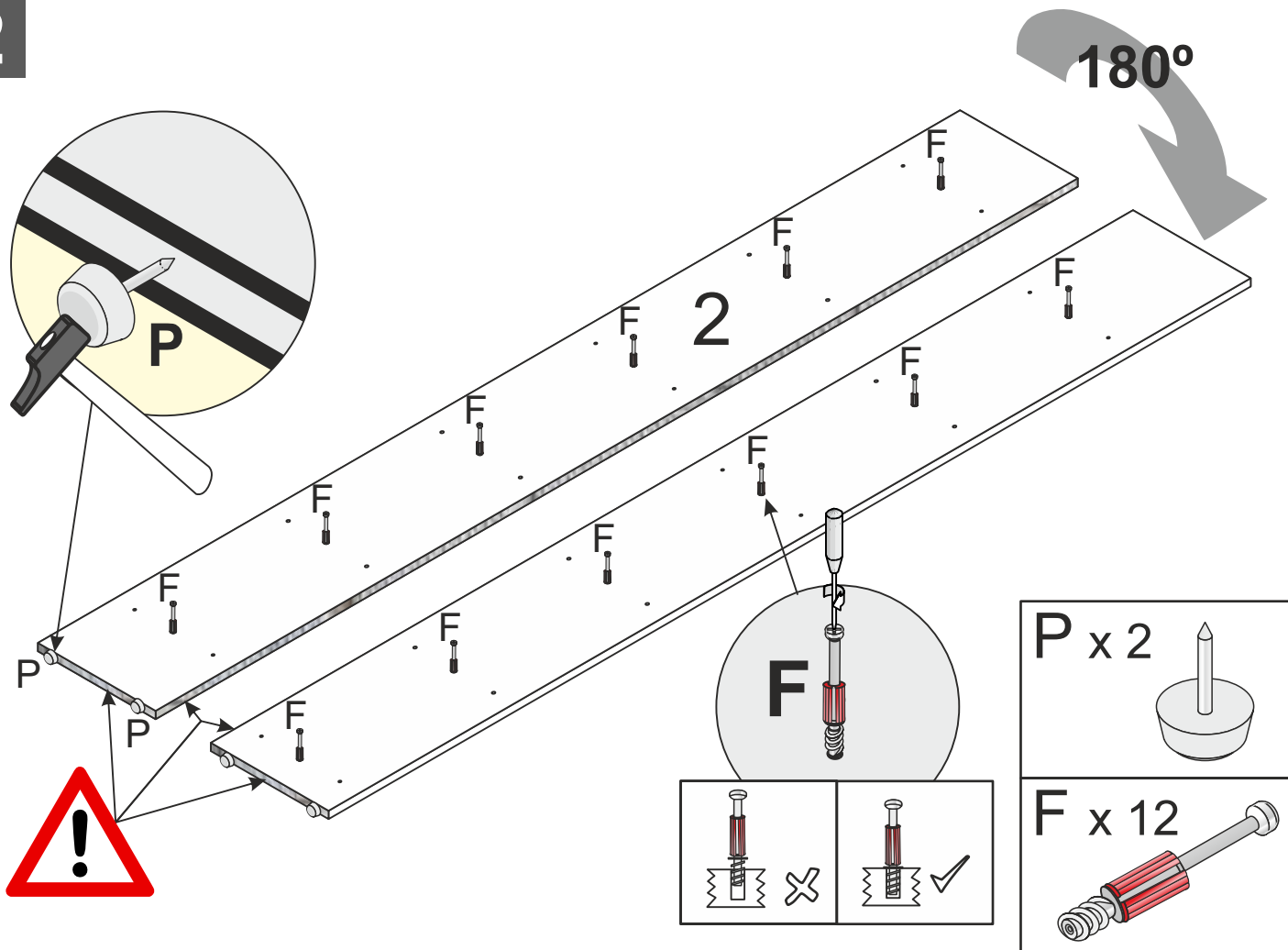

3

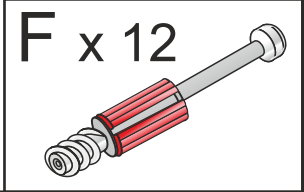
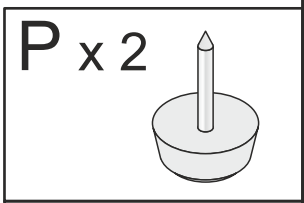
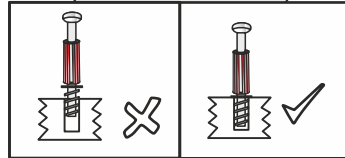
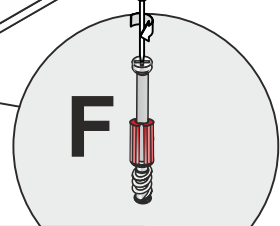
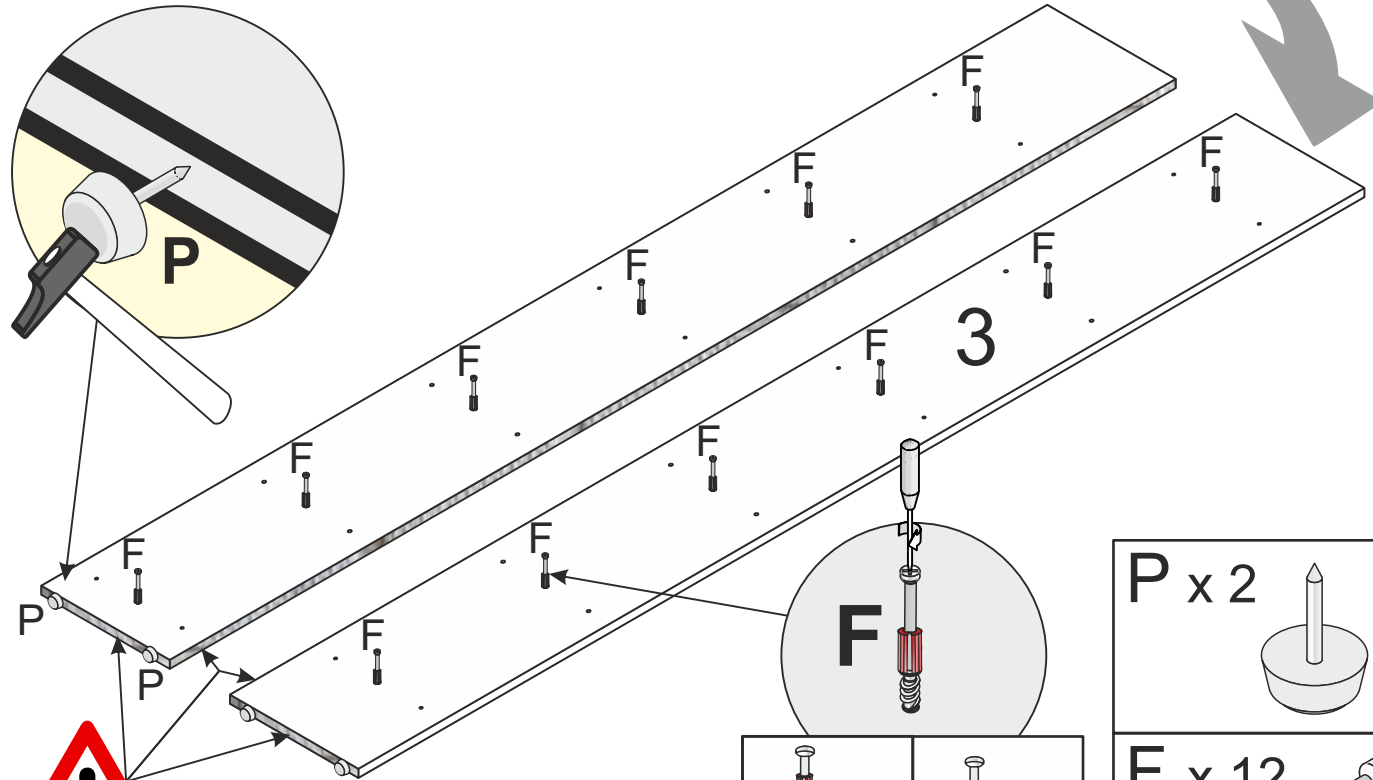
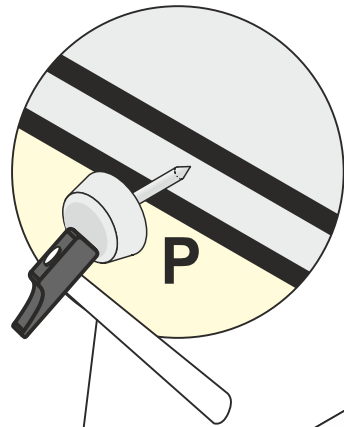

4

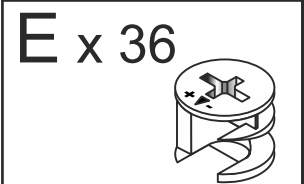
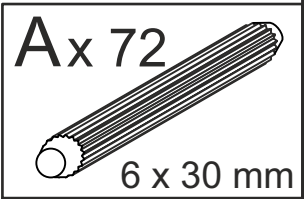
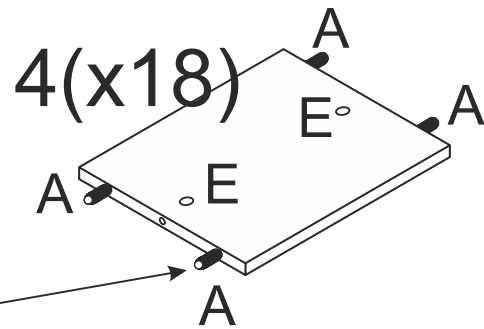
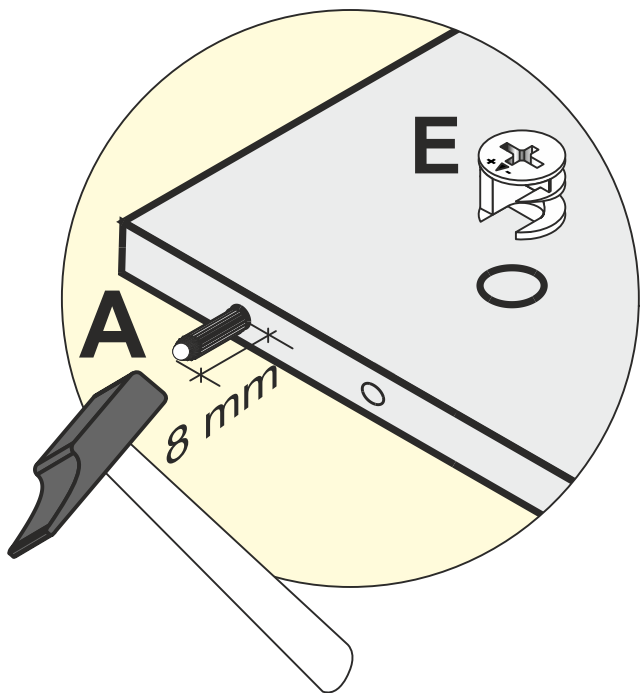

5

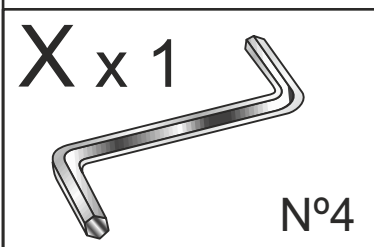
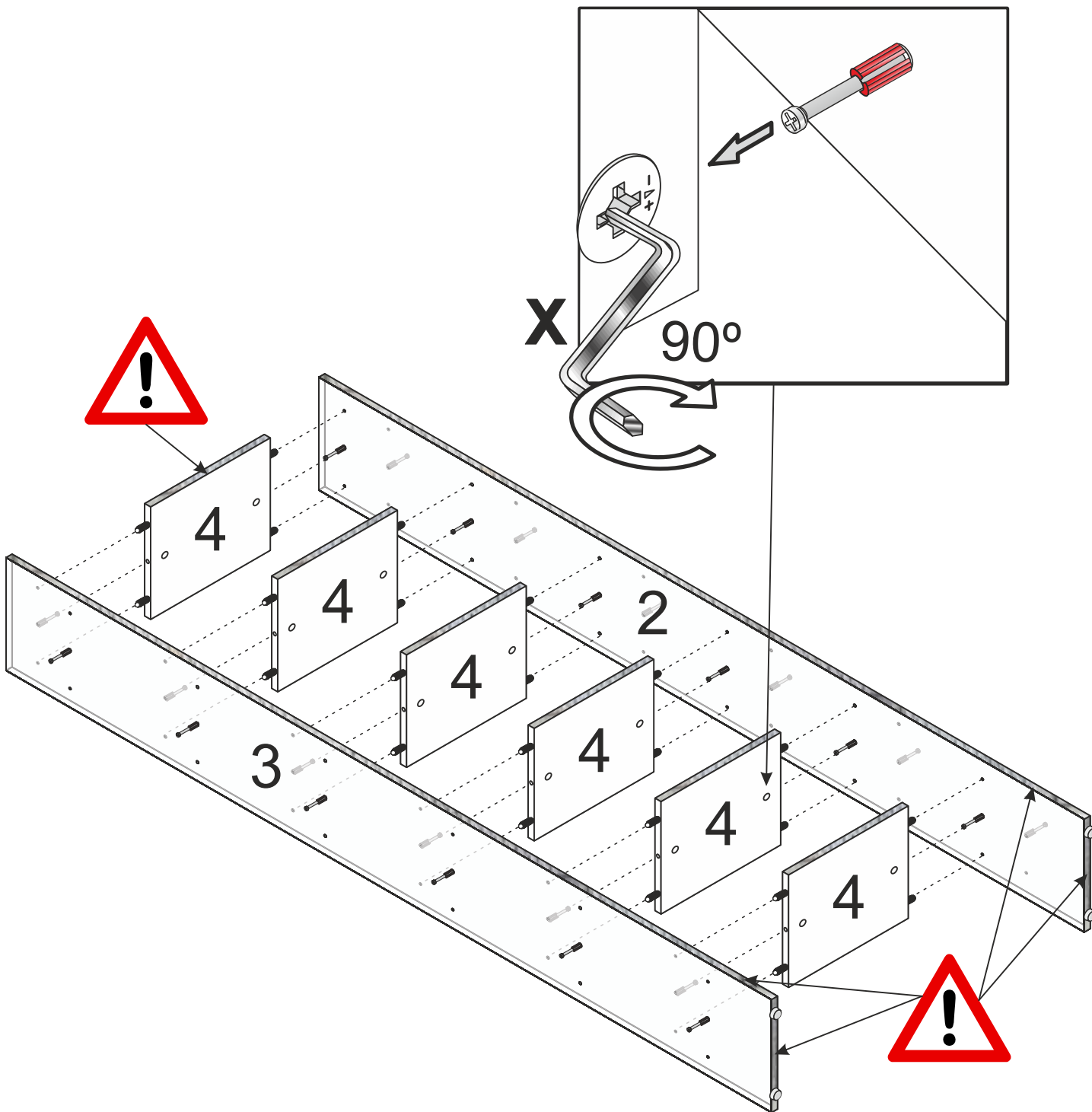

6

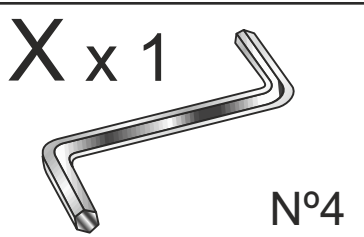
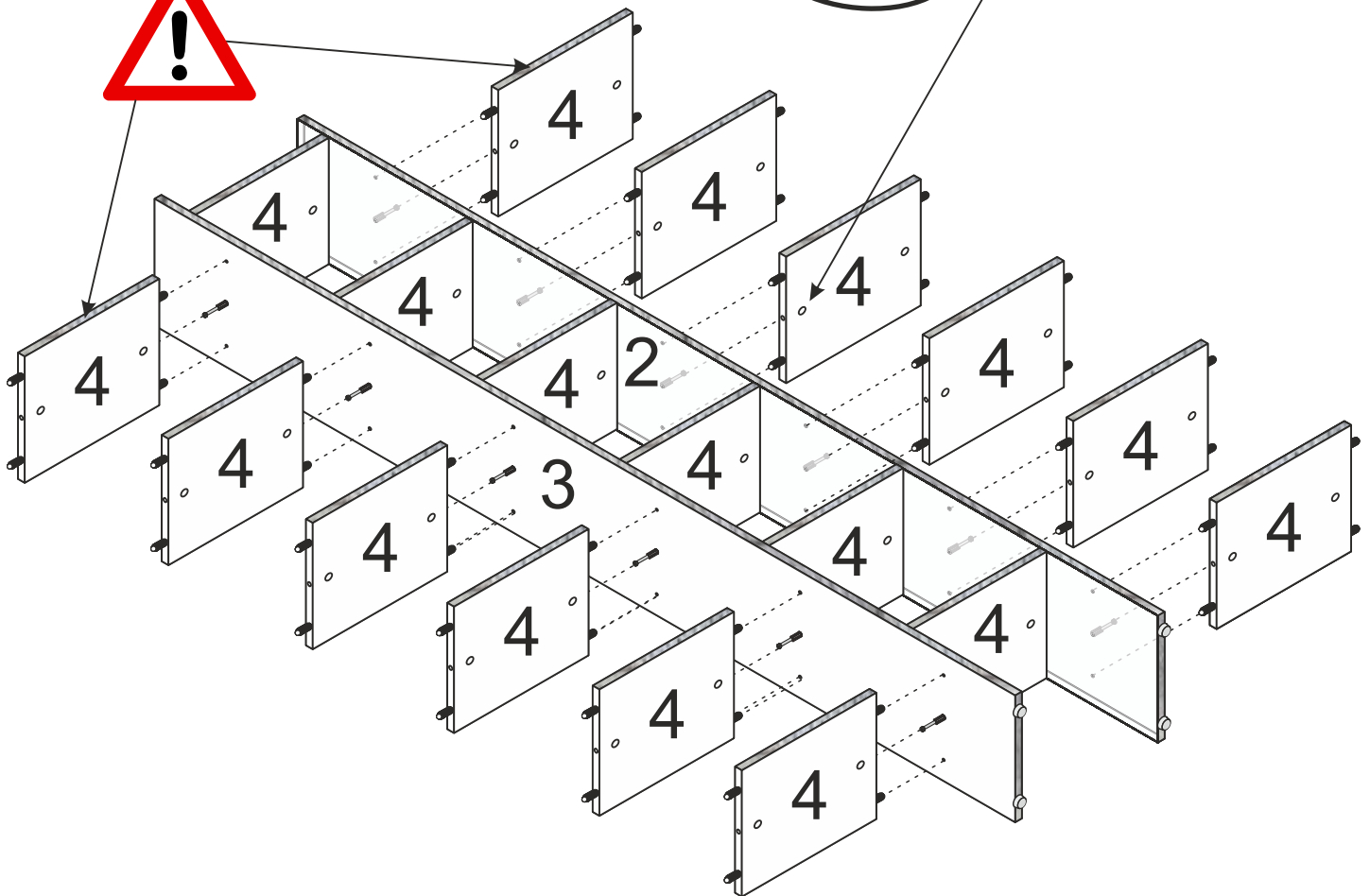
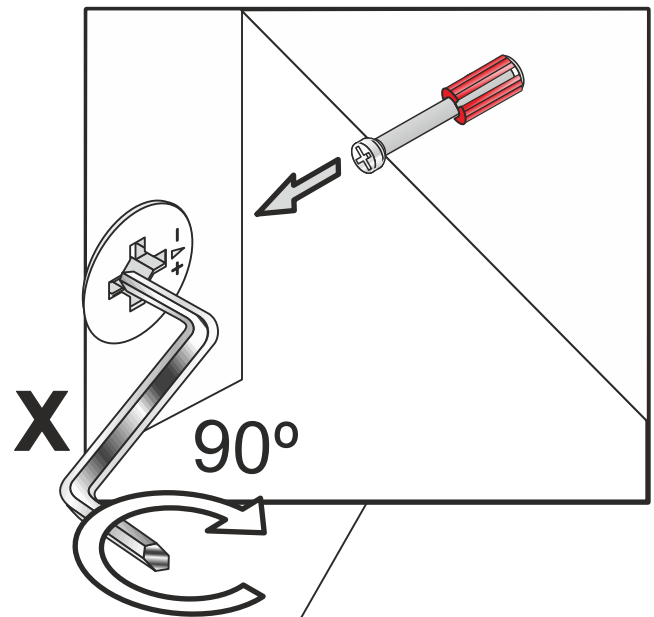

7

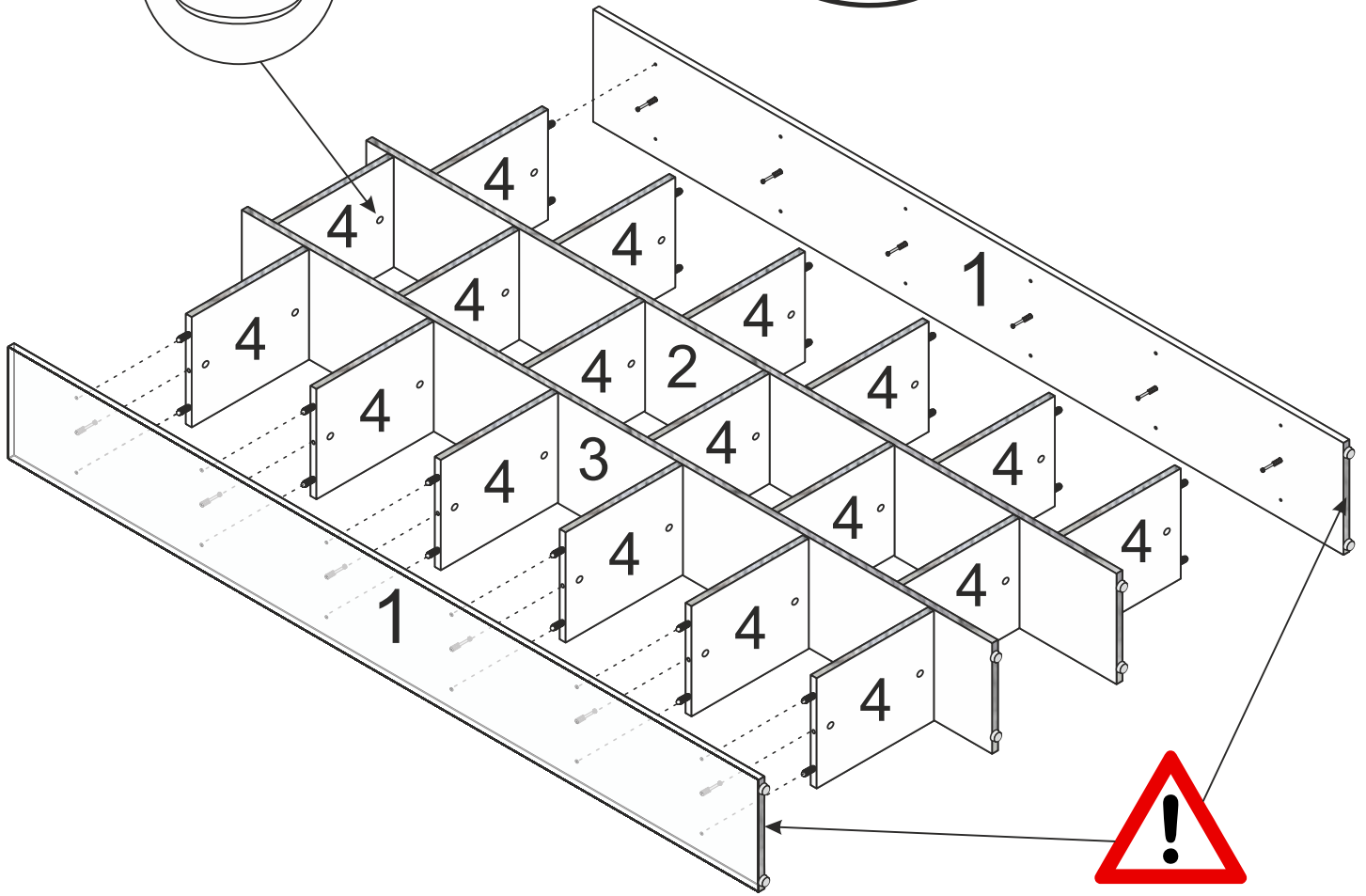
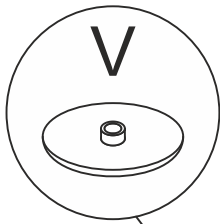
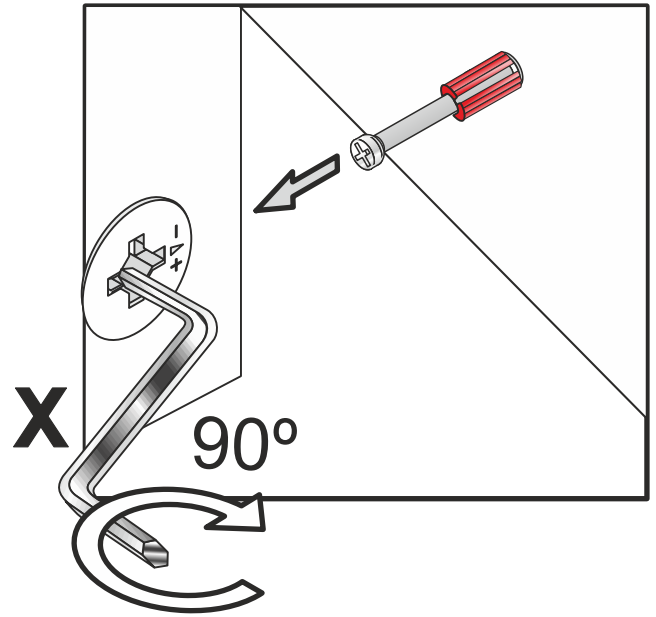

V x 36



15 mm

X x 1

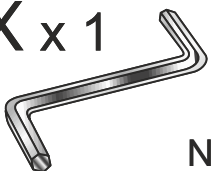

N°4

8

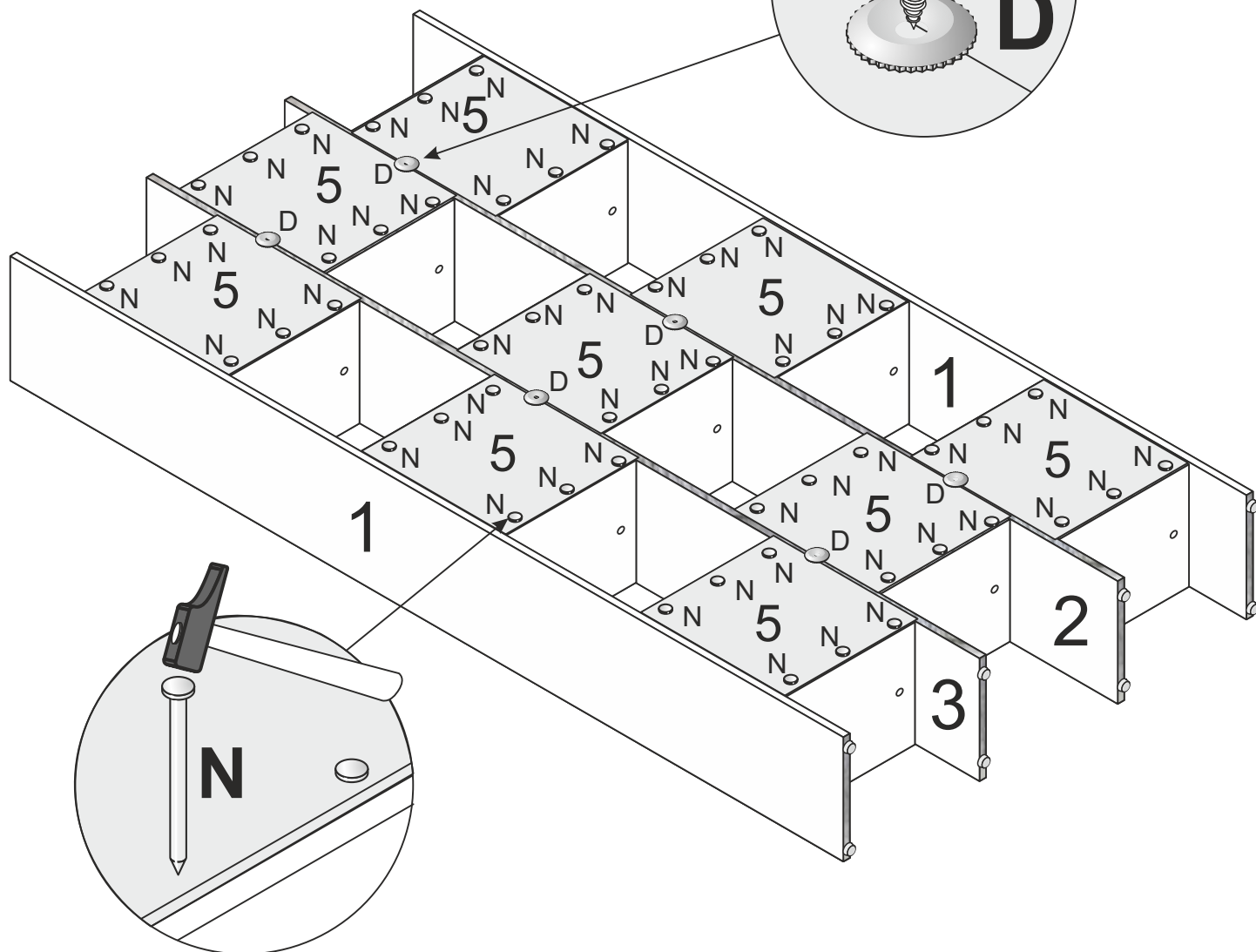
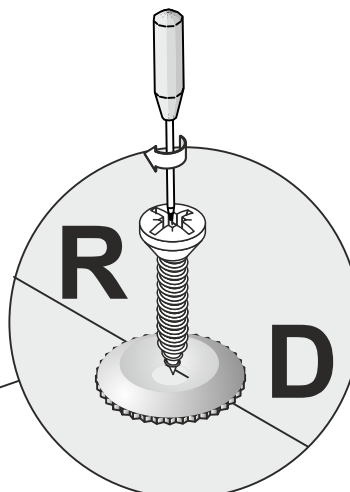
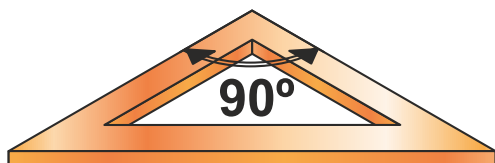

N x 54

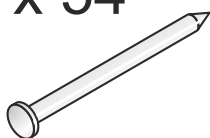

D x 6

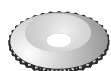

R x 6

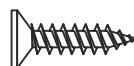

3.5 x 16 mm

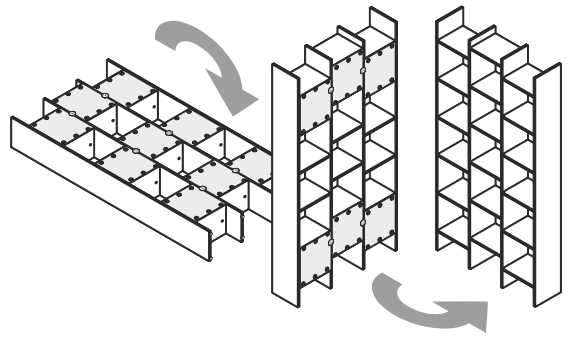
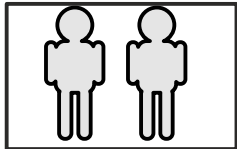

ES · USE HERRAJES ADECUADOS PARA EL MATERIAL DE LAS PAREDES DE SU CASA

EN · USE FIXING DEVICES SUITABLE FOR THE WALLS IN YOUR HOME

FR · UTILISEZ DES FIXATIONS ADAPTÉES AU MATÉRIAU DU MUR

PT · UTILIZE FERRAGENS ADEQUADAS ÀS PAREDES DA SUA CASA

IT · USA SISTEMI DI FISSAGGIO ADATTI ALLE PARETI DELLA TUA CASA

DE · BEFESTIGUNGSBESCHLÄGE BENUTZEN, DIE FÜR DIE HEIMISCHEN WÄNDE GEEIGNET SIND

GR · ΧΡΗΣΙΜΟΠΟΙΗΣΤΕ ΕΞΑΡΤΗΜΑΤΑ ΣΤΕΡΕΩΣΗΣ ΚΑΤΑΛΛΗΛΑ ΓΙΑ ΤΟΥΣ ΤΟΙΧΟΥΣ ΤΟΥ ΣΠΙΤΙΟΥ ΣΑΣ

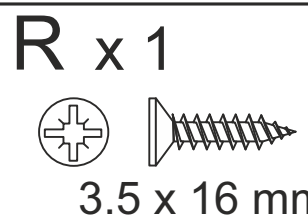
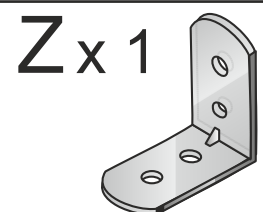
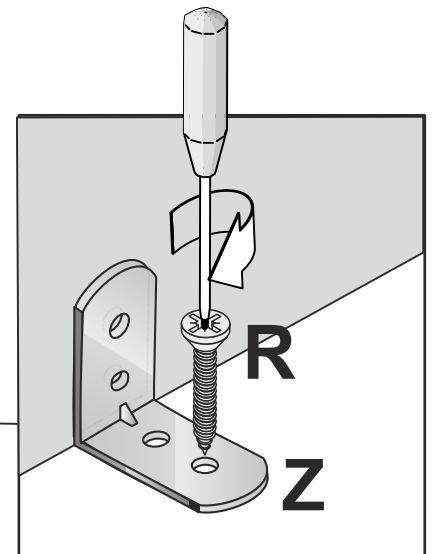
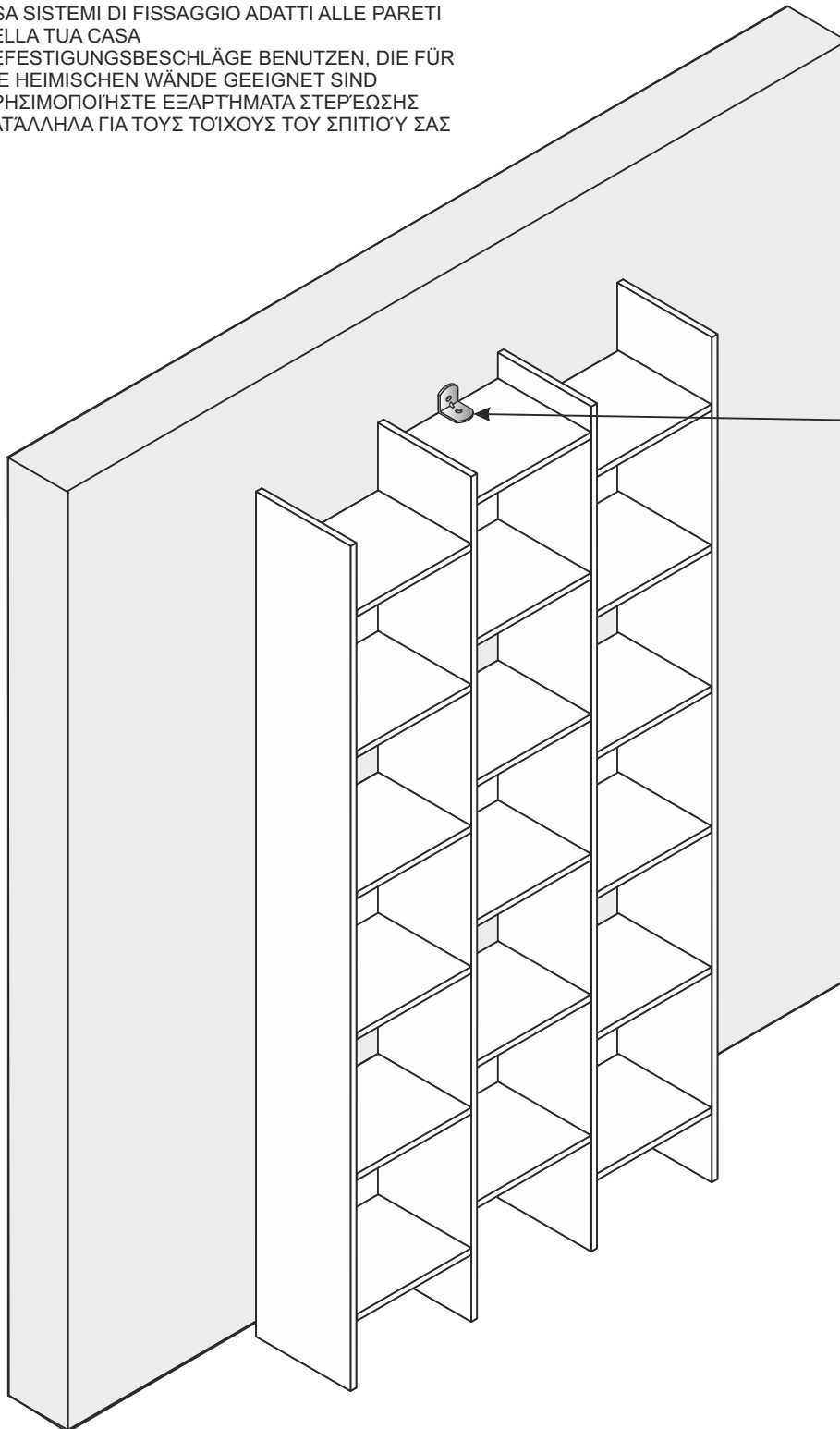

ES**RECOMENDACIONES PARA EL MONTAJE Y PARA EL USO**

- Preparar las piezas que constituyen el mueble
- Reagrupar y contar el herraje
- Preparar las herramientas necesarias
- Preparar la zona de montaje
- Realizar el montaje sobre una moqueta para evitar rayar el mueble
- No forzar nunca los ensamblajes

- No colocar cerca de fuentes de calor
- No utilizar paños, trapos o productos de limpieza que puedan rayar la superficie del mueble
- Mueble apto para uso doméstico. Ubicación en el interior de la vivienda

EN**RECOMENDATIONS FOR FITTING AND FOR USE**

- Prepare the pieces of furniture to make it up
- Group up and count the iron parts, screws... etc.
- Prepare the necessary tools
- Prepare the fitting place
- Do the fitting on a carpet so you don't damage the furniture
- Never force the fitting

- Do not put near to any sort of heat
- Do not use cloths or cleaning products that could damage the surface of the furniture
- Furniture suitable for domestic use, keep indoors

FR**CONSEILS DE MONTAGE ET POUR L'USAGE**

- Identifier les différents panneaux
- Regrouper et compter la quincaillerie
- Munissez-vous de l'outillage nécessaire
- Aménagez-vous une zone de montage. La moquette ou une couverture protégera des rayures
- Ne jamais forcer le montage

- Ne pas placer près des sources de chaleur
- N'utiliser pas de chiffons ou des produits de nettoyage qui puissent rayer la superficie du meuble
- Meuble apte pour l'usage domestique, on peut le placer à l'intérieur de la maison

PT**AVISO PARA MONTAGEM E PARA USO**

- Preparar as peças que compõem o móvel
- Reagrupar e contar as ferragens
- Preparar as ferramentas necessárias
- Preparar o local para a montagem
- Efectuar a montagem sobre uma alcatifa para evitar arranhar o móvel
- Não forçar nunca a ensambladura

- Não colocar perto de fontes de calor
- Não utilizar panos, trapos ou produtos de limpeza que possam riscar a superfície do móvel
- Móvel apto para o uso doméstico. Colocação no interior da vivenda

IT**CONSIGLI PER L'INSTALLAZIONE E L'USO**

- Preparare i componenti del mobile per il montaggio
- Ordinare e controllare la quantità della ferramenta
- Preparare gli attrezzi necessari
- Preparare un luogo idoneo al montaggio. Sistemare i componenti su un tappeto per non danneggiare le superfici
- Non forzare mai i componenti

- Non posizionare il mobile vicino a fonti di calore
- Non usare panni abrasivi né detergenti né solventi che possano danneggiare le superfici
- Questo prodotto è solo per uso domestico, non professionale. Non adatto per uso all'aperto

DE**MONTAGEHINWEISE UND GEBRAUCHSHINWEISE**

- Sortieren und identifizieren Sie die Einzelteile
- Überprüfen Sie die Anzahl der einzelnen Beschlagteile
- Legen Sie das notwendige Werkzeug bereit
- Einen montagebereich freimachen
- Montieren Sie das Möbel auf einem ebenen, weichen, sauberen Untergrund
- Niemals die verbindungen zu stark anziehen

- Nicht neben Wärmequellen platzieren.
- Für die Reinigung verwenden Sie bitte ein weiches Tuch und keinesfalls scharfe oder ätzende Reinigungsmittel.
- Das Möbel ist ausschließlich für den Gebrauch im Haus geeignet.

GR**ΣΥΜΒΟΥΛΕΣ ΣΥΝΑΡΜΟΛΟΓΗΣΗΣ ΚΑΙ ΧΡΗΣΗΣ**

- Προετοιμάστε τα μέρη του επίπλου
- Ομαδοποιήστε και μετρήστε τα μικρά μέρη (βίδες, μεντεσέδες...)
- Προετοιμάστε τα εργαλεία που θα χρειαστείτε
- Προετοιμάστε το χώρο συναρμολόγησης
- Μια μακέτα θα προφύλασσε από γρατζουνιές
- Μη ασκείτε πίεση στην εφαρμογή

- Μη το τοποθετείτε κοντά σε πηγή θερμότητας
- Μη χρησιμοποιείτε πανιά και καθαριστικά που μπορούν να καταστρέψουν την επιφάνεια
- Το έπιπλο έχει κατασκευαστεί για οικιακή χρήση, τοποθετείτε το στο εσωτερικό της οικίας

GARANTÍA - GUARANTEE - GARANTIE - GARANTIA - GARANZIA - GARANTIE - GARANTISI

- ES** · Fabricado en U.E. por FORES DISEÑO S.L. C.I.F: B-12313003 - Ctra.Nac.232; Km 11,1 C.P. 12320 - Sant Jordi (Castellón) SPAIN - el cual garantiza este producto por un periodo de **2 años** a partir de la fecha de compra, contra todo defecto de fabricación.
- Si se encuentra alguna dificultad a la hora del montaje o existe algún defecto en el mueble, puede contactar con nosotros al **964 46 52 22** o por e-mail: **postventa@fores.es** donde gustosamente atenderemos todas sus consultas. HORARIO: de lunes a viernes de 9h a 14h y de 15h a 18h.
- Esta garantía no ampara los defectos producidos por un mal montaje, utilización indebida o mal uso del mueble.
- Es imprescindible conservar el **ticket** de compra y facilitar el **Nº de Control de Calidad (Q.C.)** para cualquier consulta o reclamación.

- EN** · Manufactured in Spain by FORES DISEÑO S.L. CIF B-12313003-ctra Nac 232 km 11.1 C.P.12320-Sant Jordi, (Castellón) SPAIN - Guarantee of **2 years** from date of purchase against any fault of production.
- If a difficulty when assembly or a fault in the product is found you can contact us at **(+34) 964 46 52 22** or by email: **postventa@fores.es** where we will be pleased to help you. TIMETABLE: Monday until Friday 9-14h / 15-18h.
- The Guarantee does not cover the faults produced by an incorrect assembly or misuse of the furniture.
- Indispensable to keep the purchase **ticket** and facilitate the **Nº of Quality Control (Q.C.)** for any consult or claim.

- FR** · Fabriqué en UE par FORES DISEÑO S.L. CIF B-12313003 - Ctra Nac 232; Km 11,1 CP12320 - Sant Jordi (Castellón) Espagne - Celui ci garantie ce produit pour une période de **2 ans** à partir de la date d'achat, contre tout défaut de fabrication.
- Si vous rencontrez une quelconque difficulté à l'heure du montage ou si il y a un défaut sur le meuble, vous pouvez nous contacter par téléphone au **(+34) 964 46 52 22** ou bien par e-mail à **postventa@fores.es** où nous aurons le plaisir de vous accueillir pour toutes demandes. Nos HORAIRES sont du lundi au vendredi de 9H00 à 14H00 et de 15H00 à 18H00.
- Cette garantie ne couvre pas les défauts résultants d'un mauvais montage, d'une utilisation indue ou d'un mauvais usage du produit.
- Il est indispensable de garder le **ticket** ou facture d'achat et de communiquer le **Numéro de Control Qualité (Q.C.)** pour une quelconque demande ou réclamation.

- PT** · Fabricado U.E. por FORES DISEÑO S.L. C.I.F: B-12313003 - Ctra.Nac.232; 11,1 km C.P. 12320 - Sant Jordi (Castellón) ESPANHA - que garante este produto por um período de **2 anos** a partir da data de compra; contra defeitos de fabricação.
- Se você encontrar qualquer dificuldade na montagem ou se houver qualquer defeito no armário, você pode contactar-nos pelos seguintes meios: **(+34) 964 46 52 22** ou por e-mail: **postventa@fores.es** onde será recebido de bom grado para atenderder-mos todas as suas dúvidas. HORÁRIOS: Segunda a sexta-feira das 9h às 14h e 15h às 18h.
- Esta garantia não cobre defeitos causados pela montagem incorreta, uso indevido ou mau trato do produto.
- É essencial manter o **recibo** de compra e facilitar o **Nº Controle de Qualidade (Q.C.)** para quaisquer dúvidas ou reclamações.

- IT** · Prodotto in Spagna da: FORES DISEÑO S.L. CIF B-12313003-ctra Nac 232 km 11.1 C.P.12320-Sant Jordi, (Castellón) SPAIN. Garantito **2 Anni** dalla data di acquisto contro ogni difetto di produzione.
- In caso di difficoltà nel montaggio o di mancanza di componenti potete chiamare il **(+34) 964 46 52 22** o inviare email a: **postventa@fores.es**
- Il servizio è attivo dal Lunedì al Venerdì ore 9:00-14:00 / 15:00-18:00 Saremo lieti di aiutarvi.
- La garanzia non copre difetti o danni dovuti a montaggio scorretto o ad uso improprio del prodotto.
- La garanzia è valida solo in presenza dello **scontrino di acquisto** e del **Nº di controllo qualità (Q.C.)** presente nella confezione

- DE** · Hergestellt in Spanien von FORES DISEÑO S.L. CIF B-12313003-ctra Nac 232 km 11.1 CP12320-Sant Jordi (Castellón) SPANIEN - Garantie von **2 Jahren** ab kaufdatum gegen jede störung der produktion.
- Wenn Sie irgendwelche schwierigkeiten bei der montage zu finden oder es irgendeinen defekt in dem schrank, können sie uns unter **(+34) 964 46 52 22** oder per email an: **postventa@fores.es**, wo wir gerne besuchen, um alle Ihre Fragen. ÖFFNUNGSZEITEN: Montag bis Freitag von 9h bis 14h und 15h bis 18h.
- Diese Garantie gilt nicht für Mängel, die durch unsachgemäße Installation, unsachgemäße Behandlung und Verwendung des Geräts verursacht werden.
- Unentbehrlich, um den **Kauf Ticket** behalten und erleichtern die Anzahl der **Qualitätskontrollzahl (Q.C.)** für alle zu konsultieren oder Anspruch.

- GR** · Κατασκευάζεται στην Ισπανία από CIF B-12313003-Ctra Nac 232 χλμ 11.1 CP12320-Sant Jordi, στην Ισπανία - Η εγγύηση ισχύει για **2 έτη** από την αρχική ημερομηνία αγοράς και καλύπτει ελαττωματικά υλικά ή ελαττωματική κατασκευή του προϊόντος.
- Σε περίπτωση δυσκολίας σας κατά την συναρμολόγηση ή πιθανής βλάβης στο προϊόν, μπορείτε να επικοινωνήσετε μαζί μας στο **(+34) 964 46 52 22** ή μέσω email: **postventa@fores.es** Θα χαρούμε να σας βοηθήσουμε. ΗΜΕΡΕΣ & ΩΡΕΣ ΕΞΥΠΗΡΕΤΗΣΗΣ: Δευτέρα έως Παρασκευή 9:00-14:00 & 15:00-18:00.
- Η εγγύηση δεν καλύπτει τις βλάβες που προέρχονται από λάθη στην συναρμολόγηση ή την μη ορθολογική χρήση των επίπλων.
- Είναι απαραίτητο να κρατήσετε την **απόδειξη αγοράς** του προϊόντος και τον **αριθμό ποιοτικού ελέγχου (Q.C.)**, ώστε να διευκολύνετε οποιαδήποτε διαδικασία αίτησης ή συμβουλής χρειαστείτε.

Nº de Control de Calidad (Q.C.):
 Nº of Quality Control (Q.C.):
 Nº de Contrôle Qualité (Q.C.):
 Nº de Controle de Qualidade (Q.C.):
 Nº di Controllo qualità (Q.C.):
 Qualitätskontrollzahl (Q.C.):
 Ποιοτικός έλεγχος Αριθμός (Q.C.):



GUARDE ESTE NÚMERO
 SAVE THIS NUMBER
 SAUVEZ CE NUMÉRO
 GUARDE ESTE NÚMERO
 SALVA QUESTO NUMERO
 SPEICHERN SIE DIESE NUMMER
 ΦΥΛΑΞΤΕ ΑΥΤΟ ΤΟ ΑΡΙΘΜΟ

Q.C.**0000.18**



ESTANTERÍA - BOOKCASE - ÉTAGÈRE - PRATELEIRA -
SCAFFALE - BÜCHERGESTELL - ΡΑΦΙΕΡΑ

