



ángulos, palomillas y soportes

# Ángulos, palomillas y soportes

## Corner braces, shelf brackets and supports

### EMBELLECEDOR LISO

Trim plain

	código	acabado	medida	contenido	embalaje		8431488
	Nº		A				
caja 	45121	latón	12 mm		100		451213
	45141	latón	14 mm		100		451411
	45161	latón	16 mm		100		451619
	45181	latón	18 mm		100		451817
	45122	níquel	12 mm		100		451220
	45142	níquel	14 mm		100		451428
	45162	níquel	16 mm		100		451626
	45182	níquel	18 mm		100		451824
blister 	90380	latón	12 mm	4	10		903804
	90381	latón	14 mm	4	10		903811
	90382	latón	16 mm	4	10		903828
	90383	latón	18 mm	4	10		903835
	90384	níquel	12 mm	4	10		903842
	90385	níquel	14 mm	4	10		903859
	90386	níquel	16 mm	4	10		903866
	90387	níquel	18 mm	4	10		903873



### EMBELLECEDOR FACETADO

rim diamond

	código	acabado	medida	contenido	embalaje		8431488
	Nº		A				
caja 	46121	latón	12 mm		100		461212
	46141	latón	14 mm		100		461410
	46161	latón	16 mm		100		461618
	46181	latón	18 mm		100		461816
	46122	níquel	12 mm		100		461229
	46142	níquel	14 mm		100		461427
	46162	níquel	16 mm		100		461625
	46182	níquel	18 mm		100		461823
blister 	90388	latón	12 mm	4	10		903880
	90389	latón	14 mm	4	10		903897
	90390	latón	16 mm	4	10		903903
	90391	latón	18 mm	4	10		903910
	90392	níquel	12 mm	4	10		903927
	90393	níquel	14 mm	4	10		903934
	90394	níquel	16 mm	4	10		903941
	90395	níquel	18 mm	4	10		903958



### SUJETALUNAS

Trim for glass

	código	acabado	medida	contenido	embalaje		8431488
	Nº						
caja 	47011	latón liso	2-6 mm		100		470115
	47111	latón liso	5-8 mm		100		471112
	47012	níquel liso	2-6 mm		100		470122
	47112	níquel liso	5-8 mm		100		471129
	48011	latón facetado	2-6 mm		100		480114
	48111	latón facetado	5-8 mm		100		481111
	48012	níquel facetado	2-6 mm		100		480121
	48112	níquel facetado	5-8 mm		100		481128
blister 	90396	latón liso	2-6 mm	4	10		903965
	90397	latón liso	5-8 mm	4	10		903972
	90398	níquel liso	2-6 mm	4	10		903989
	90399	níquel liso	5-8 mm	4	10		903996
	90400	latón facetado	2-6 mm	4	10		904009
	90401	latón facetado	5-8 mm	4	10		904016
	90402	níquel facetado	2-6 mm	4	10		904023
	90403	níquel facetado	5-8 mm	4	10		904030



### SOPORTE CILÍNDRICO

Cylindrical support

	código	acabado	medida	contenido	embalaje	8431488
	Nº		A			
caja	32701	oro	5-6 mm		50	327013
	32702	chromo brillo	5-6 mm		50	327020
	32703	chromo mate	5-6 mm		50	327037
	32704	blanco	5-6 mm		50	327044
	32712	chromo brillo	8-10 mm		50	327129
	32713	chromo mate	8-10 mm		50	327136
blister	90404	oro	5-6 mm	2	10	904047
	90405	chromo brillo	5-6 mm	2	10	904054
	90406	chromo mate	5-6 mm	2	10	904061
	90407	blanco	5-6 mm	2	10	904078
	90410	chromo brillo	8-10 mm	2	10	904108
	90411	chromo mate	8-10 mm	2	10	904115

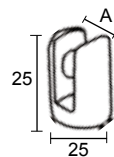

### SOPORTE ESFÉRICO

Spherical support

	código	acabado	medida	contenido	embalaje	8431488
	Nº		A			
caja	32601	oro	5-6 mm		25	326016
	32602	chromo brillo	5-6 mm		25	326023
	32603	chromo mate	5-6 mm		25	326030
	32604	blanco	5-6 mm		25	326047
	32605	negro	5-6 mm		25	326054
blister	90414	oro	5-6 mm	2	10	904146
	90415	chromo brillo	5-6 mm	2	10	904153
	90416	chromo mate	5-6 mm	2	10	904160
	90417	blanco	5-6 mm	2	10	904177
	90418	negro	5-6 mm	2	10	904184



### SOPORTE MEDIA LUNA

Stocking moon support

	código	acabado	medida	contenido	embalaje	8431488
	Nº		A			
caja	32501	oro	6 mm		50	325019
	32502	chromo brillo	6 mm		50	325026
	32503	chromo mate	6 mm		50	325033
	32504	blanco	6 mm		50	325040
	32511	oro	10 mm		50	325118
	32512	chromo brillo	10 mm		50	325125
	32513	chromo mate	10 mm		50	325132
	32514	blanco	10 mm		50	325149
blister	90419	oro	6 mm	2	10	904191
	90420	chromo brillo	6 mm	2	10	904207
	90421	chromo mate	6 mm	2	10	904214
	90422	blanco	6 mm	2	10	904221
	90428	oro	10 mm	2	10	904283
	90429	chromo brillo	10 mm	2	10	904290
	90430	chromo mate	10 mm	2	10	904306
90431	blanco	10 mm	2	10	904313	



# Ángulos, palomillas y soportes

## Corner braces, shelf brackets and supports



### JGO SOPORTE P/ESPEJOS

Set support for mirrors

	código	acabado	medida	contenido	embalaje		8431488
	Nº						
blister	30513	zincado	45x25 mm	1	25		305134

ZN



### SOPORTE BALDA OCULTO

Concealed support

	código	acabado	medida	contenido	embalaje		8431488
	Nº		A				
caja	31121	bicromatado	150 mm		20		311210
	31122	bicromatado	190 mm		20		311227

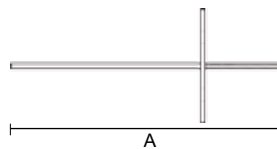

BC



### SOPORTE BALDA OCULTO

Concealed support

	código	acabado	medida	contenido	embalaje		8431488
	Nº		A B				
	31123	zincado	8x100 mm		20		311234
	31124	zincado	8x140 mm		20		311241
caja	31125	zincado	10x100 mm		20		311258
	31126	zincado	10x140 mm		20		311265
	31127	zincado	10x170 mm		20		311272



ZN

# Ángulos, palomillas y soportes

## Corner braces, shelf brackets and supports

### SOPORTE BALDA OCULTA SB01

Concealed support SB02

	código	acabado	medida	contenido	embalaje	8431488
	Nº					
caja	31128	zincado	150 mm	10		311289

ZN

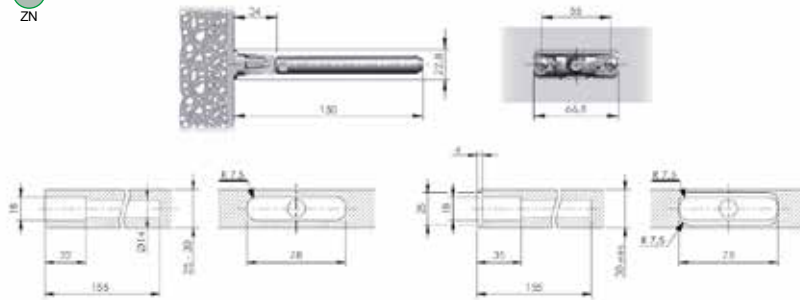

### SOPORTE BALDA OCULTA SB02

Concealed support SB02

	código	acabado	medida	contenido	embalaje	8431488
	Nº					
caja	31129	zincado	150 mm	10		311296

ZN

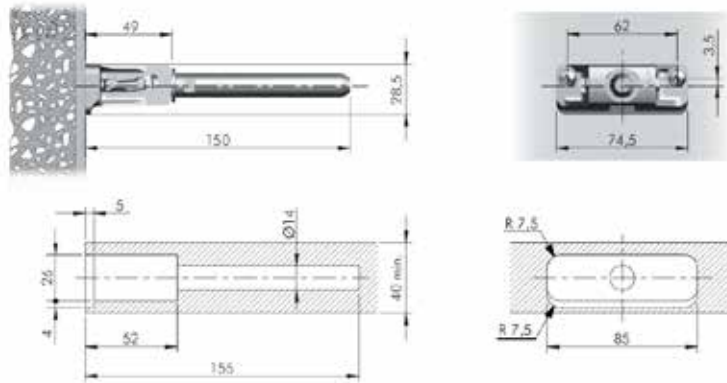

# Ángulos, palomillas y soportes

## Corner braces, shelf brackets and supports



Apertura 24 mm  
Opening 24 mm

### SOPORTE PELÍCANO PEQUEÑO

*Pelican small support*

código		acabado	medida	contenido	embalaje	8431488	
Nº							
caja	31241	blanco	42x53 mm		2		312415
	31243	oro	42x53 mm		2		312439
	31245	chromo mate	42x53 mm		2		312453

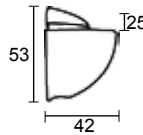

### SOPORTE PELÍCANO MEDIANO

*Pelican medium support*

código		acabado	medida	contenido	embalaje	8431488	
Nº							
	31201	blanco	75x65 mm		2		312019
	31202	negro	75x65 mm		2		312026
caja	31203	oro	75x65 mm		2		312033
	31204	chromo brillo	75x65 mm		2		312040
	31205	chromo mate	75x65 mm		2		312057
	90622	blanco	75x65 mm	2	10		906225
	90623	negro	75x65 mm	2	10		906232
blister	90624	oro	75x65 mm	2	10		906249
	90625	chromo brillo	75x65 mm	2	10		906256
	90626	chromo mate	75x65 mm	2	10		906263

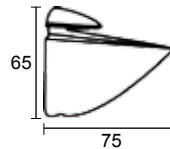

Apertura 24 mm  
Opening 24 mm

### SOPORTE PELÍCANO GRANDE

*Pelican big support*

código		acabado	medida	contenido	embalaje	8431488	
Nº							
	31221	blanco	110x87 mm		2		312217
	31222	negro	110x87 mm		2		312224
	31223	oro	110x87 mm		2		312231
caja	31224	chromo mate	110x87 mm		2		312248
	31225	níquel satinado	110x87 mm		2		312255
	31226	cuero	110x87 mm		2		312262
	31227	latón envejecido	110x87 mm		2		312279

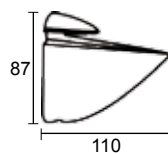

Apertura 40 mm  
Opening 40 mm

# Ángulos, palomillas y soportes

## Corner braces, shelf brackets and supports

### SOPORTE PELÍCANO SP1

Pelican support SP1

	código	acabado	medida	contenido	embalaje	8431488
	Nº					
caja	31206	chromo mate	27,5x39x26,5 mm	2		312064

CM



Apertura 3-11 mm - Opening 3-11 mm

### SOPORTE PELÍCANO SP2

Pelican support SP2

	código	acabado	medida	contenido	embalaje	8431488
	Nº					
caja	31207	chromo mate	111x70x36,5 mm	2		312071

CM

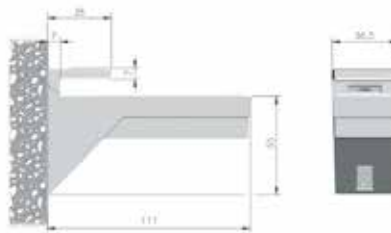

Apertura 8-30 mm - Opening 8-30 mm

### SOPORTE PELÍCANO SP3

Pelican support SP3

	código	acabado	medida	contenido	embalaje	8431488
	Nº					
caja	31208	chromo mate	111x70x36,5 mm	2		312088

CM

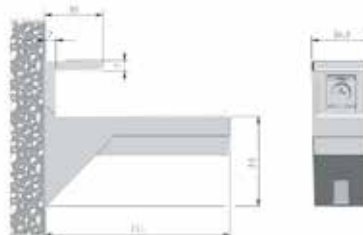

Apertura 25-50 mm - Opening 25-50 mm

# Ángulos, palomillas y soportes

## Corner braces, shelf brackets and supports



Apertura 20 mm  
Opening 20 mm

### SOPORTE PELÍCANO SP5

SP5 Pelican support

	código	acabado	medida	contenido	embalaje		8431488
	Nº						
caja	31209	chromo mate	30x46 mm		2		312095



Apertura 36 mm  
Opening 36 mm

### SOPORTE PELÍCANO SP6

SP6 Pelican support

	código	acabado	medida	contenido	embalaje		8431488
	Nº						
caja	31210	chromo mate	77x112 mm		2		312101

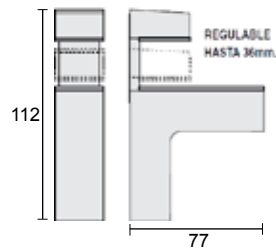

### SOPORTE MICROONDAS

caja Microwave support

	código	acabado	peso	contenido	embalaje		8431488
	Nº						
	80451	blanco	40 kg		1/11		804514
	80452	gris	40 kg		1/11		804521

Extensible 320-485 mm - Extension 320-485 mm

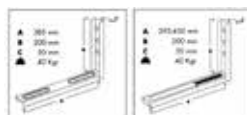



# Ángulos, palomillas y soportes

## Corner braces, shelf brackets and supports

### JGO SOPORTE AIRE ACONDICIONADO

Set air conditioning support

	código	acabado	medida	contenido	embalaje	8431488
	Nº		A B			
	18516	beige	500x400 mm		1	185163
ean13	18517	beige	500x450 mm		1	185170
	18518	beige	500x500 mm		1	185187

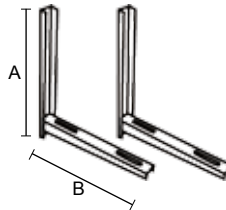

### JGO AMORTIGUADORES

Set dampers

	código	acabado	peso	contenido	embalaje	8431488
	Nº					
	18519	negro	35 kgs		1/8	185194
ean13	18520	negro	45 kgs		1/5	185200

1 juego= 4 piezas - 1 set = 4 units



### SOPORTE GARRAFA AIRE ACONDICIONADO

Cylinder support air conditioning

	código	acabado	garrafa	contenido	embalaje	8431488
	Nº					
caja	18521	beige	5 litros		1/5	185217



Incluye garrafa

# Ángulos, palomillas y soportes

## Corner braces, shelf brackets and supports



### CREMALLERA DE ALUMINIO

Aluminium rack

	código	acabado	medida	contenido	embalaje		8431488
	Nº						
	51100	blanco	1000 mm		1		511009
	51150	blanco	1500 mm		1		511504
ean13	51200	blanco	2000 mm		1		512006
	52100	plata	1000 mm		1		521008
	52150	plata	1500 mm		1		521503
	52200	plata	2000 mm		1		522005



### PALOMILLA DE ALUMINIO

Aluminium shelf bracket

	código	acabado	medida	contenido	embalaje		8431488
	Nº						
	51015	blanco	150 mm		2		510156
	51020	blanco	200 mm		2		510200
	51025	blanco	250 mm		2		510255
	51030	blanco	300 mm		2		510309
	51035	blanco	350 mm		2		510354
	51040	blanco	400 mm		2		510408
blister	52015	plata	150 mm		2		520155
	52020	plata	200 mm		2		520209
	52025	plata	250 mm		2		520254
	52030	plata	300 mm		2		520308
	52035	plata	350 mm		2		520353
	52040	plata	400 mm		2		520407

Precio unitario - Unit price



### ESQUINERO ALUMINIO

Aluminium Corner

	código	acabado	medida	contenido	embalaje		8431488
	Nº		A B C				
	55062	blanco	20x20x2,5 mts		5		550626
	55063	plata	20x20x2,5 mts		5		550633
ean13	55064	blanco	25x25x2,5 mts		5		550640
	55065	plata	25x25x2,5 mts		5		550657

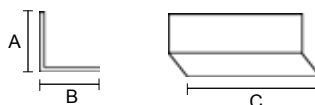

# Ángulos, palomillas y soportes

## Corner braces, shelf brackets and supports

### ESCUADRA 3 POSICIONES

Three position shelf bracket

código	acabado	medida	contenido	embalaje	8431488
Nº		A B C			
37330	blanco	300x300x30 mm	10	10	373300
37340	blanco	400x400x35 mm	6	6	373409
37430	cromado	300x300x30 mm	10	10	374307
37440	cromado	400x400x35 mm	6	6	374406

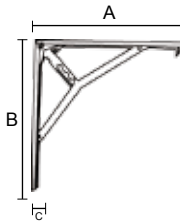

### PALOMILLA ORNAMENTAL

Shelf bracket ornamental series

código	acabado	medida	contenido	embalaje	8431488
Nº		A B			
33010	negro	100x90 mm	10	10	330105
33015	negro	150x115 mm	10	10	330150
33020	negro	200x150 mm	10	10	330204
33025	negro	250x190 mm	10	10	330259

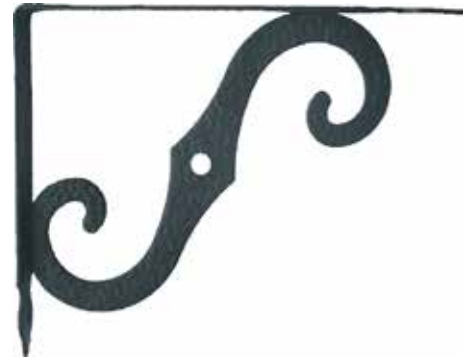
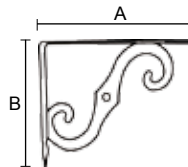

### PALOMILLA REFORZADA

Strong shelf bracket

código	acabado	medida	contenido	embalaje	8431488
Nº		A B			
37530	blanco	300x220 mm	10	10	375304
37540	blanco	400x280 mm	10	10	375403
37550	blanco	500x350 mm	10	10	375502
37630	gris	300x220 mm	10	10	376301
37640	gris	400x280 mm	10	10	376400
37650	gris	500x350 mm	10	10	376509

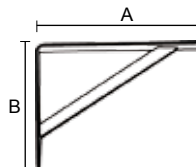

# Ángulos, palomillas y soportes

## Corner braces, shelf brackets and supports



### PALOMILLA CLÁSICA

Classic shelf bracket

código	acabado	medida	contenido	embalaje		8431488
Nº		A B				
80100	blanco	100x75 mm		20		801001
80125	blanco	125x100 mm		20		801254
80150	blanco	150x125 mm		20		801506
80175	blanco	175x150 mm		20		801759
ean13 80200	blanco	200x150 mm		20		802008
80250	blanco	250x200 mm		20		802503
80300	blanco	300x250 mm		20		803005
80350	blanco	350x300 mm		20		803500
80400	blanco	400x350 mm		20		804002
80450	blanco	450x400 mm		20		804507

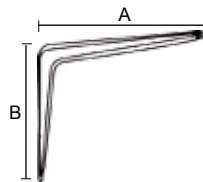

BL

### PALOMILLA PLUS

Plus Sheli Bracket

código	acabado	medida	contenido	embalaje		8431488
Nº		A B				
80453	blanco	150x125 mm		20		804538
80454	blanco	200x150 mm		20		804545
80455	blanco	250x200 mm		20		804552
80456	blanco	300x250 mm		20		804569
80457	blanco	350x300 mm		20		804576
80458	negro	150x125 mm		20		804583
80459	negro	200x150 mm		20		804590
ean13 80460	negro	250x200 mm		20		804606
80461	negro	300x250 mm		20		804613
80462	negro	350x300 mm		20		804620
80463	gris	150x125 mm		20		804637
80464	gris	200x150 mm		20		804644
80465	gris	250x200 mm		20		804651
80466	gris	300x250 mm		20		804668
80467	gris	350x300 mm		20		804675

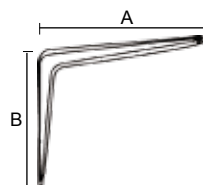

BL NE GR

### PALOMILLA SUPER

Super shelf bracket

código	acabado	medida	contenido	embalaje		8431488
Nº		A B				
35101	blanco	125x125 mm		25		351018
35102	blanco	150x125 mm		25		351025
35103	blanco	200x150 mm		20		351032
ean13 35104	blanco	250x200 mm		10		351049
35105	blanco	300x250 mm		10		351056
35106	blanco	350x250 mm		6		351063
35107	blanco	400x300 mm		6		351070

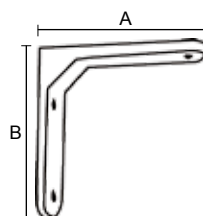

BL



# Ángulos, palomillas y soportes

## Corner braces, shelf brackets and supports

### ÁNGULO SUPER

Super corner brace

	código	acabado	medida	contenido	embalaje		8431488
	Nº		A B				
	35030	blanco	30x30 mm		100		350301
caja	35050	blanco	50x50 mm		100		350509
	35075	blanco	75x75 mm		50		350752
	35100	blanco	100x100 mm		50		351001
	91024	blanco	30X30 mm		100		910246
ean13	91025	blanco	50x50 mm		100		910253
	91026	blanco	75x75 mm		50		910260
	91027	blanco	100x100 mm		50		910277
	90444	blanco	30X30 mm	4	10		904443
	90446	blanco	50x50 mm	4	10		904467
blister	90448	blanco	75x75 mm	4	10		904481
	90658	blanco	100x100 mm	4	10		906584



Incluye tornillos en el blister - Includes screws on the blister

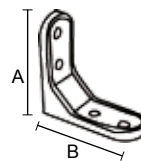

### ÁNGULO SUPER

Super corner brace

	código	acabado	medida	contenido	embalaje		8431488
	Nº		A B				
	36030	negro	30x30 mm		100		360300
caja	36050	negro	50x50 mm		100		360508
	36075	negro	75x75 mm		50		360751
	36100	negro	100x100 mm		50		361000
	91032	negro	30X30 mm		100		910321
ean13	91033	negro	50x50 mm		100		910338
	91034	negro	75x75 mm		50		910345
	91035	negro	100x100 mm		50		910352
	90445	negro	30X30 mm	4	10		904450
	90447	negro	50x50 mm	4	10		904474
blister	90449	negro	75x75 mm	4	10		904498
	90659	negro	100x100 mm	4	10		906591



Incluye tornillos en el blister - Includes screws on the blister

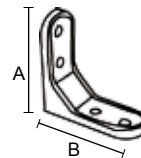

### ÁNGULO SUPER

Super corner brace

	código	acabado	medida	contenido	embalaje		8431488
	Nº		A B				
	35530	zincado	30X30 mm		100		355306
caja	35550	zincado	50x50 mm		100		355504
	35575	zincado	75x75 mm		50		355757
	35510	zincado	100x100 mm		50		355108
	91028	zincado	30X30 mm		100		910284
ean13	91029	zincado	50x50 mm		100		910291
	91030	zincado	75x75 mm		50		910307
	91031	zincado	100x100 mm		50		910314



Incluye tornillos en el blister - Includes screws on the blister

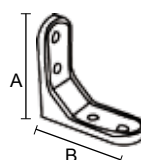

# Ángulos, palomillas y soportes

## Corner braces, shelf brackets and supports



### ÁNGULO DE REFUERZO

Corner brace

	código	acabado	medida	contenido	embalaje	8431488
	Nº		A B C			
	39020	bicromatado	20x20x19 mm		100/1200	390208
	39030	bicromatado	30x30x19 mm		100/1200	390307
	39040	bicromatado	40x40x19 mm		100/1200	390406
caja	39050	bicromatado	50x50x19 mm		100/700	390505
	39060	bicromatado	60x60x19 mm		100/700	390604
	39080	bicromatado	80x80x19 mm		100/500	390802
	39100	bicromatado	100x100x19 mm		50/250	391007
	91000	bicromatado	20x20x19 mm		100	910000
	91001	bicromatado	30x30x19 mm		100	910017
	91002	bicromatado	40x40x19 mm		100	910024
ean13	91003	bicromatado	50x50x19 mm		100	910031
	91004	bicromatado	60x60x19 mm		100	910048
	91005	bicromatado	80x80x19 mm		100	910055
	91006	bicromatado	100x100x19 mm		50	910062
	90433	bicromatado	20x20x19 mm	4	10	904337
	90434	bicromatado	30x30x19 mm	4	10	904344
	90435	bicromatado	40x40x19 mm	4	10	904351
blister	90436	bicromatado	50x50x19 mm	4	10	904368
	90437	bicromatado	60x60x19 mm	4	10	904375
	90438	bicromatado	80x80x19 mm	4	10	904382
	90655	bicromatado	100x100x19 mm	4	10	906553

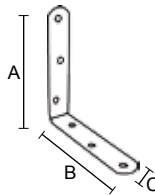

Incluye tornillos en el blister - Includes screws on the blister



Presentación en bolsa de 10 unidades



### ÁNGULO DE REFUERZO

Corner brace

	código	acabado	medida	contenido	embalaje	8431488
	Nº		A B C			
	39101	zincado	20x20x15 mm		100	391014
	39102	zincado	30x30x15 mm		100	391021
	39103	zincado	40x40x15 mm		100	391038
caja	39104	zincado	50x50x15 mm		100	391045
	39105	zincado	60x60x15 mm		100	391052
	39106	zincado	80x80x15 mm		100	391069
	39107	zincado	100x100x15 mm		100	391076
	91082	zincado	20x20x15 mm		100	910826
	91083	zincado	30x30x15 mm		100	910833
	91084	zincado	40x40x15 mm		100	910840
ean13	91085	zincado	50x50x15 mm		100	910857
	91086	zincado	60x60x15 mm		100	910864
	91087	zincado	80x80x15 mm		100	910871
	91088	zincado	100x100x15 mm		100	910888
	91122	zincado	20x20x15 mm	4	10	911229
	91123	zincado	30x30x15 mm	4	10	911236
blister	91124	zincado	40x40x15 mm	4	10	911243
	91125	zincado	50x50x15 mm	4	10	911250
	91126	zincado	60x60x15 mm	4	10	911267
	91127	zincado	80x80x15 mm	4	10	911274

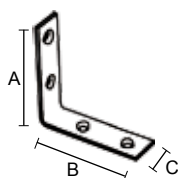

Incluye tornillos en el blister - Includes screws on the blister

Espesor 2 mm - Thick 2 mm



# Ángulos, palomillas y soportes

## Corner braces, shelf brackets and supports

### ÁNGULO DE REFUERZO

Corner brace

	código	acabado	medida	contenido	embalaje		8431488
	Nº		A B C				
	39000	blanco	20x20x19 mm		100		390000
	39001	blanco	30x30x19 mm		100		390017
caja	39002	blanco	40x40x19 mm		100		390024
	39003	blanco	50x50x19 mm		100		390031
	39004	blanco	60x60x19 mm		100		390048
	91624	blanco	20x20x19 mm		100		916248
	91625	blanco	30x30x19 mm		100		916255
ean13	91626	blanco	40x40x19 mm		100		916262
	91627	blanco	50x50x19 mm		100		916279
	91628	blanco	60x60x19 mm		100		916286
	91140	blanco	20x20x19 mm	4	10		911403
	91141	blanco	30x30x19 mm	4	10		911412
blister	91142	blanco	40x40x19 mm	4	10		911427
	91143	blanco	50x50x19 mm	4	10		911434
	91144	blanco	60x60x19 mm	4	10		911441

Incluye tornillos en el blister - Includes screws on the blister



BL

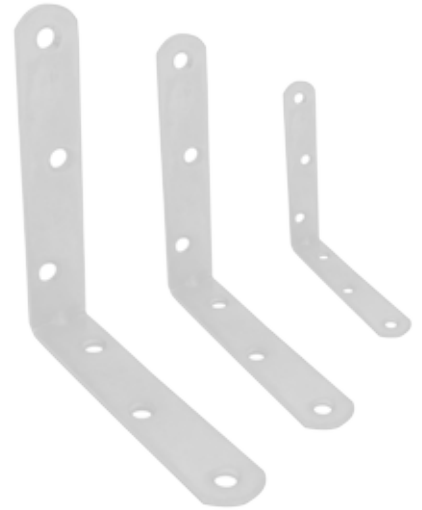
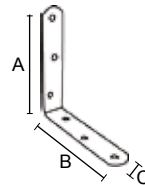

### ÁNGULO DE REFUERZO

Corner brace

	código	acabado	medida	contenido	embalaje		8431488
	Nº		A B C				
	39121	zincado	20x20x30 mm		50		391212
	39122	zincado	30x30x30 mm		50		391229
ean13	39123	zincado	40x40x30 mm		50		391236
	39124	zincado	50x50x30 mm		50		391243
	39125	zincado	60x60x30 mm		50		391250

Espesor 2 mm - Thick 2 mm



ZN

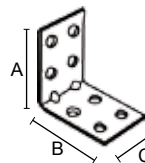

# Ángulos, palomillas y soportes

## Corner braces, shelf brackets and supports



### ÁNGULO DE FIJACIÓN

Fix corner

	código	acabado	medida	contenido	embalaje		8431488
	Nº		A B C				
ean13	39131	zincado	38x28x23 mm		100		391311
blister	91139	zincado	38x28x23 mm	4	10		911397

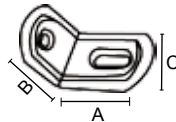

Incluye tornillos en el blister - Includes screws on the blister  
Espesor 1 mm - Thick 1 mm



### ÁNGULO DE FIJACIÓN

Fix corner

	código	acabado	medida	contenido	embalaje		8431488
	Nº		A B C				
ean13	39132	zincado	28x28x30 mm		100		391328

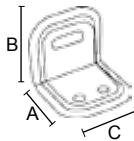

Espesor 1 mm - Thick 1 mm



### ÁNGULO DE REFUERZO

Corner brace

	código	acabado	medida	contenido	embalaje		8431488
	Nº		A B C				
ean13	39116	zincado	20x20x40 mm		100		391168
blister	91134	zincado	20x20x40 mm	4	10		911342

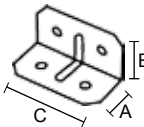

Incluye tornillos en el blister - Includes screws on the blister  
Espesor 1 mm - Thick 1 mm



### ÁNGULO DE REFUERZO

Corner brace

	código	acabado	medida	contenido	embalaje		8431488
	Nº		A B C				
ean13	39117	zincado	20x20x50 mm		100		391175
blister	91135	zincado	20x20x50 mm	4	10		911359

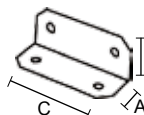

Incluye tornillos en el blister - Includes screws on the blister  
Espesor 1 mm - Thick 1 mm





# Ángulos, palomillas y soportes

## Corner braces, shelf brackets and supports

### ÁNGULO DE REFUERZO

Corner brace

	código	acabado	medida	contenido	embalaje	8431488
	Nº		A B C			
ean13	39118	zincado	21x21x67 mm	100	100	391182
blister	91136	zincado	21x21x67 mm	4	10	911366

Incluye tornillos en el blister - Includes screws on the blister

Esesor 1 mm - Thick 1 mm

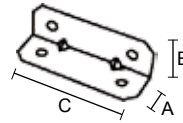

### ÁNGULO DE REFUERZO

Corner brace

	código	acabado	medida	contenido	embalaje	8431488
	Nº		A B C			
ean13	39119	zincado	21x21x86 mm	100	100	391199
blister	91137	zincado	21x21x86 mm	4	10	911373

Incluye tornillos en el blister - Includes screws on the blister

Esesor 1 mm - Thick 1 mm

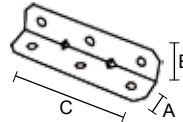

### ÁNGULO DE REFUERZO

Corner brace

	código	acabado	medida	contenido	embalaje	8431488
	Nº		A B C			
ean13	39120	zincado	40x40x90 mm	50	50	391205
blister	91138	zincado	40x40x90 mm	4	10	911380

Incluye tornillos en el blister - Includes screws on the blister

Esesor 1 mm - Thick 1 mm

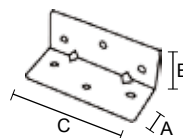

# Ángulos, palomillas y soportes

## Corner braces, shelf brackets and supports



### PLACA CUADRADA

Square plate

	código	acabado	medida	contenido	embalaje	8431488
	Nº		A B			
ean13	39114	zincado	45x45 mm		100	391144
blister	91132	zincado	45x45 mm	4	10	911328

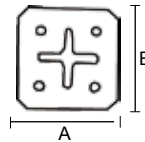

Incluye tornillos en el blister - Includes screws on the blister  
Espesor 1 mm - Thick 1 mm



### PLACA RECTANGULAR

Rectangular plate

	código	acabado	medida	contenido	embalaje	8431488
	Nº		A B			
ean13	39115	zincado	70x35 mm		100	391151
blister	91133	zincado	70x35 mm	4	10	911335

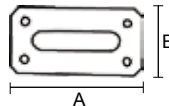

Incluye tornillos en el blister - Includes screws on the blister  
Espesor 1 mm - Thick 1 mm



### PLACA DE UNIÓN

Unión straight plate

	código	acabado	medida	contenido	embalaje	8431488
	Nº		A B			
	39126	zincado	40x30 mm		50	391267
	39127	zincado	60x30 mm		50	391274
ean13	39128	zincado	80x30 mm		50	391281
	39129	zincado	100x30 mm		50	391298
	39130	zincado	120x30 mm		50	391304

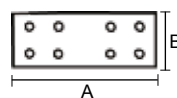

Espesor 2 mm - Thick 2 mm



# Ángulos, palomillas y soportes

## Corner braces, shelf brackets and supports

### PLACA RECTA UNIÓN

Unión straight plate

	código	acabado	medida	contenido	embalaje	8431488
	Nº		A B			
caja	38040	bicromatado	40x16 mm	100	100	380407
	38060	bicromatado	60x16 mm	100	100	380605
	38080	bicromatado	80x19 mm	100	100	380803
	38100	bicromatado	100x19 mm	100	100	381008
	38120	bicromatado	120x19 mm	100	100	381206
ean13	91019	bicromatado	40x16 mm	100	100	910192
	91020	bicromatado	60x16 mm	100	100	910208
	91021	bicromatado	80x19 mm	100	100	910215
	91022	bicromatado	100x19 mm	100	100	910222
	91023	bicromatado	120x19 mm	100	100	910239
blister	90516	bicromatado	40x16 mm	4	10	905167
	90517	bicromatado	60x16 mm	4	10	905174
	90518	bicromatado	80x19 mm	4	10	905181
	90519	bicromatado	100x19 mm	4	10	905198

Incluye tornillos en el blister - Includes screws on the blister

Espesor 2 mm en placas de 80 mm, 100 mm y 120 mm  
 Espesor de 1,5 mm en 40 mm y 60 mm  
 2 mm thickness in 80mm, 100mm and 120mm plates  
 1,5 mm thickness in 40 mm and 60 mm plates

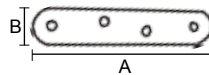

### PLACA RECTA UNIÓN

Unión straight plate

	código	acabado	medida	contenido	embalaje	8431488
	Nº		A B			
caja	38240	zincado	40x15 mm	100	100	382401
	38260	zincado	60x15 mm	100	100	382609
	38280	zincado	80x15 mm	100	100	382807
	38210	zincado	100x15 mm	100	100	382104
	38212	zincado	120x15 mm	100	100	382128
ean13	91014	zincado	40x15 mm	100	100	910147
	91015	zincado	60x15 mm	100	100	910154
	91016	zincado	80x15 mm	100	100	910161
	91017	zincado	100x15 mm	100	100	910178
	91018	zincado	120x15 mm	100	100	910185
blister	90520	zincado	40x15 mm	4	10	905204
	90521	zincado	60x15 mm	4	10	905211
	90522	zincado	80x15 mm	4	10	905228
	90523	zincado	100x15 mm	4	10	905235

Incluye tornillos en el blister - Includes screws on the blister

Espesor 2 mm - Thick 2 mm

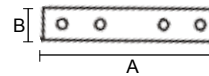

### PLACA CARTELA

Porter plate

	código	acabado	medida	contenido	embalaje	8431488
	Nº		A B			
caja	38130	zincado	30x13 mm	300	300	381305
	38140	zincado	40x15 mm	200	200	381404
	38150	zincado	50x17 mm	200	200	381503
	38160	zincado	60x20 mm	100	100	381602
ean13	91036	zincado	30x13 mm	300	300	910369
	91037	zincado	40x15 mm	200	200	910376
	91038	zincado	50x17 mm	200	200	910383
	91039	zincado	60x20 mm	100	100	910390
blister	90844	zincado	30x13 mm	4	10	908441
	90845	zincado	40x15 mm	4	10	908458
	90846	zincado	50x17 mm	4	10	908465
	90847	zincado	60x20 mm	4	10	908472

Incluye tornillos en el blister - Includes screws on the blister

Espesor 2 mm - Thick 2 mm

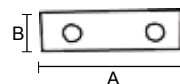

# Ángulos, palomillas y soportes

## Corner braces, shelf brackets and supports



### ESCUADRA PLANA

Flat corner brace

	código	acabado	medida	contenido	embalaje		8431488
	Nº		A B C				
	37030	bicromatado	30x30x12 mm		100		370309
	37040	bicromatado	40x40x12 mm		100		370408
	37051	bicromatado	50x50x14 mm		100		370514
caja	37060	bicromatado	60x60x17 mm		100		370606
	37080	bicromatado	80x80x20 mm		100		370804
	37100	bicromatado	100x100x20 mm		100		371009
	37120	bicromatado	120x120x20 mm		100		371207
	91007	bicromatado	30x30x12 mm		100		910079
	91008	bicromatado	40x40x12 mm		100		910086
	91009	bicromatado	50x50x14 mm		100		910093
ean13	91010	bicromatado	60x60x17 mm		100		910109
	91011	bicromatado	80x80x20 mm		100		910116
	91012	bicromatado	100x100x20 mm		100		910123
	91013	bicromatado	120x120x20 mm		100		910130
	90439	bicromatado	30x30x12 mm	8	10		904399
	90440	bicromatado	40x40x12 mm	8	10		904405
	90441	bicromatado	50x50x14 mm	4	10		904412
blister	90442	bicromatado	60x60x17 mm	4	10		904429
	90443	bicromatado	80x80x20 mm	4	10		904436
	90656	bicromatado	100x100x20 mm	4	10		906560
	90657	bicromatado	120x120x20 mm	4	10		906577

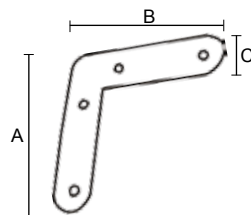

Incluye tornillos en el blister - Includes screws on the blister



### ESCUADRA PLANA

Flat corner brace

	código	acabado	medida	contenido	embalaje		8431488
	Nº		A B C				
	39108	zincado	40x40x12 mm		100		391083
	39109	zincado	50x50x12 mm		100		391090
	39110	zincado	60x60x12 mm		100		391106
caja	39111	zincado	80x80x18 mm		100		391113
	39112	zincado	100x100x18 mm		50		391120
	39113	zincado	120x120x18 mm		50		391137
	91089	zincado	40x40x12 mm		100		910895
	91090	zincado	50x50x12 mm		100		910901
ean13	91091	zincado	60x60x12 mm		100		910918
	91092	zincado	80x80x18 mm		100		910925
	91093	zincado	100x100x18 mm		50		910932
	91094	zincado	120x120x18 mm		50		910949
	91128	zincado	40x40x12 mm	4	10		911281
	91129	zincado	50x50x12 mm	4	10		911298
blister	91130	zincado	60x60x12 mm	4	10		911304
	91131	zincado	80x80x18 mm	4	10		911311

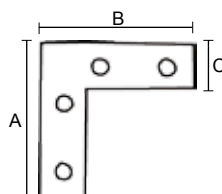

Incluye tornillos en el blister - Includes screws on the blister  
(40,50 y 60) Espesor 1,8 mm - Thick 1,8 mm  
(80,100 y 120) Espesor 2 mm - Thick 2 mm



# Ángulos, palomillas y soportes

## Corner braces, shelf brackets and supports

### PLACA PESANTE

Heavy plate

	código	acabado	medida	contenido	embalaje	8431488
	Nº		A B			
	39134	zincado	80x50 mm	50		391342
ean13	39135	zincado	120x50 mm	50		391359
	39136	zincado	160x50 mm	25		391366
	39137	zincado	200x50 mm	25		391373

Espesor 2,5 mm - Thick 2,5 mm

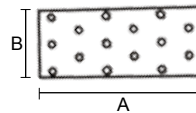

### PLACA RECTA PERFORADA

Straight perforated plate

	código	acabado	medida	contenido	embalaje	8431488
	Nº		A B			
	39156	39156	160x40 mm	50		391564
ean13	39157	39157	200x60 mm	25		391571
	39158	39158	240x80 mm	25		391588

Espesor 2,5 mm - Thick 2,5 mm

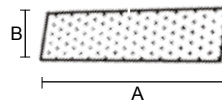

### PLACA FORMA "T"

Plate form "T"

	código	acabado	medida	contenido	embalaje	8431488
	Nº		A B C			
ean13	39146	zincado	160x45x100 mm	20		391465

Espesor 2,5 mm - Thickness 2,5 mm

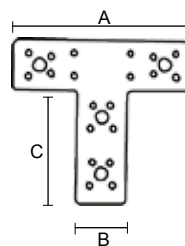

# Ángulos, palomillas y soportes

## Corner braces, shelf brackets and supports



### ÁNGULO PESANTE

Heavy corner

	código	acabado	medida	contenido	embalaje	8431488
	Nº		A B C			
	39149	zincado	40x40x20 mm		100	391496
ean13	39150	zincado	40x40x40 mm		50	391502
	39151	zincado	50x50x40 mm		50	391519

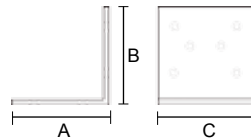

Espesor 2 mm - Thick 2 mm



### ÁNGULO PESANTE

Heavy corner

	código	acabado	medida	contenido	embalaje	8431488
	Nº		A B C			
	39138	zincado	40x40x50 mm		50	391380
ean13	39139	zincado	60x60x50 mm		50	391397
	39140	zincado	80x80x50 mm		25	391403
	39141	zincado	100x100x50 mm		25	391410

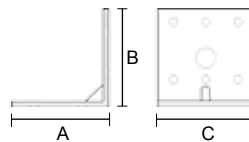

Espesor 2 mm - Thick 2 mm



### ÁNGULO PESANTE

Heavy corner

	código	acabado	medida	contenido	embalaje	8431488
	Nº		A B C			
	39152	zincado	60x60x40 mm		50	391526
	39153	zincado	60x60x60 mm		50	391533
ean13	39154	zincado	60x60x80 mm		25	391540
	39155	zincado	80x80x80 mm		25	391557

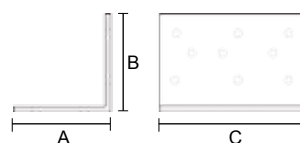

Espesor 2 mm - Thick 2 mm



# Ángulos, palomillas y soportes

## Corner braces, shelf brackets and supports

### ÁNGULO PESANTE

Heavy corner

código	acabado	medida	contenido	embalaje	8431488
Nº		A			
ean13	39142	zincado	60x60x50 mm	50	391427

Espesor 2,5 mm - Thick 2,5 mm

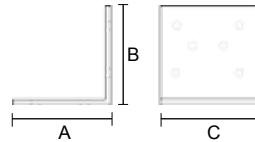

### ÁNGULO PESANTE

Heavy corner

código	acabado	medida	contenido	embalaje	8431488
Nº		A			
ean13	39143	zincado	85x85x65 mm	25	391434

Espesor 2,5 mm - Thick 2,5 mm

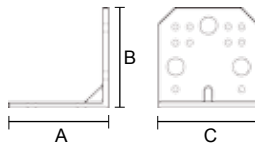

### ÁNGULO PESANTE

Heavy corner

código	acabado	medida	contenido	embalaje	8431488
Nº		A			
ean13	39144	zincado	100x100x90 mm	20	391441

Espesor 2,5 mm - Thick 2,5 mm

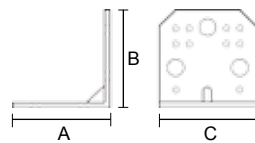

### ÁNGULO PESANTE INCLINADO 135°

Heavy corner 135° inclined

código	acabado	medida	contenido	embalaje	8431488
Nº		A			
ean13	39145	zincado	80x80x50 mm	25	391458

Espesor 2,5 mm - Thick 2,5 mm

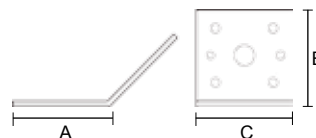

# Ángulos, palomillas y soportes

## Corner braces, shelf brackets and supports



### ÁNGULO ANCLAJE C/TORNILLO

Corner anchor with screw

	código	acabado	medida	contenido	embalaje	8431488
	Nº					
ean13	39133	zincado	30x36 mm		50	391335

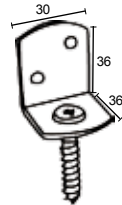

Espesor 2 mm - 2 mm thickness



### PLACA C/TUERCA

Plate with nut

	código	acabado	medida	contenido	embalaje	8431488
	Nº					
ean13	39147	zincado	M8		50	391472
	39148	zincado	M10		50	391489

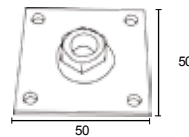

Espesor 3 mm - 3 mm thickness



### SOPORTE VIGA INCLINADA

Support beam inclined

	código	acabado	medida	contenido	embalaje	8431488
	Nº		A  B C			
ean13	39175	zincado	70x70x80 mm		1/15	391755
	39176	zincado	90x90x95 mm		1/10	391762

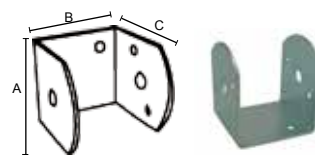

Espesor 3 mm - 3 mm thickness



### SOPORTE VIGA UNIVERSAL

Universal beam support

	código	acabado	medida	contenido	embalaje	8431488
	Nº					
ean13	39165	zincado	120 mm		1/15	391656

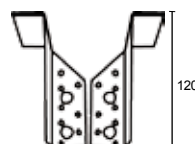

Espesor 2 mm - 2 mm thickness





# Ángulos, palomillas y soportes

## Corner braces, shelf brackets and supports

### SOPORTE VIGA ABIERTO

Open beam support

	código	acabado	medida	contenido	embalaje	8431488
	Nº		A  B			
	39159	zincado	70x125 mm		1/15	391595
ean13	39161	zincado	80x120 mm		1/15	391618
	39163	zincado	100x140 mm		1/15	391632

Espesor 2 mm - Thickness 2 mm

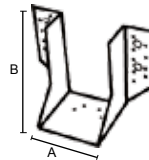

### SOPORTE VIGA CERRADO

Close beam support

	código	acabado	medida	contenido	embalaje	8431488
	Nº		A  B			
	39160	zincado	70x125 mm		1/15	391601
ean13	39162	zincado	80x120 mm		1/15	391625
	39164	zincado	100x140 mm		1/15	391649

Espesor 2 mm - Thickness 2 mm

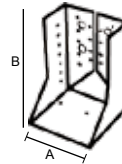

### SOPORTE VIGA PIE

Base beam support

	código	acabado	medida	contenido	embalaje	8431488
	Nº		A  B			
	39166	zincado	71x71 mm		1/8	391663
ean13	39167	zincado	91x91 mm		1/8	391670
	39169	zincado	121x121 mm		1/8	391694

Espesor 4 mm - Thickness 4 mm

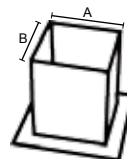

### BASE VIGA CLAVAR

Nail beam base

	código	acabado	medida	contenido	embalaje	8431488
	Nº		A  B			
	39173	zincado	70x70 mm		1/2	391731
ean13	39174	zincado	90x90 mm		1/2	391748

Largo 400 mm - Long 400 mm

Espesor 4 mm - Thickness 2 mm



# Ángulos, palomillas y soportes

## Corner braces, shelf brackets and supports



### SOPORTE POSTE REDONDO

Round post support

	código	acabado	medida	contenido	embalaje		8431488
	Nº						
ean13	39177	zincado	80-100 mm		1/25		391779

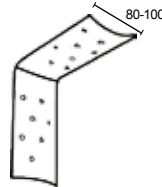

Espesor 2,5 mm - Thickness 2



### SOPORTE POSTE REDONDO

Round post support

	código	acabado	medida	contenido	embalaje		8431488
	Nº						
ean13	39178	zincado	80-100 mm		1/25		391786

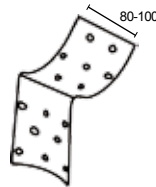

Espesor 2,5 mm - Thickness 2,5 mm



### BASE SUELO POSTE REDONDO

Soil base round post

	código	acabado	medida	contenido	embalaje		8431488
	Nº		A				
	39179	zincado	80 mm		1/4		391793
ean13	39180	zincado	100 mm		1/4		391809
	39181	zincado	120 mm		1/4		391816

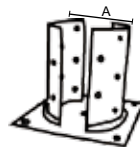

Espesor 4 mm - Thickness 4 mm



### BASE CLAVAR POSTE REDONDO

Nail base round post

	código	acabado	medida	contenido	embalaje		8431488
	Nº		A				
	39182	zincado	80 mm		1/2		391823
ean13	39183	zincado	100 mm		1/2		391830



Largo 400 mm - Long 400 mm  
Espesor 4 mm - Thickness 4 mm

