



Instrucciones de montaje
 Assembly instructions
 Notice de montage
 Istruzioni di montaggio
 Instruções de montagem

serieveneto

El procedimiento de montaje puede realizarlo personal no profesional
 The assembly procedure can be carried out by non-professionals
 La procédure de montage peut être effectuée par des non-professionnels.
 La procedura di montaggio può essere effettuata da persone non esperte
 O procedimento de montagem pode ser realizado por pessoal não profissional



Deben leerse las instrucciones de uso antes de maniobrar el producto
 Please read the instructions for use before operating the product.
 Les instructions d'utilisation doivent être lues avant toute manipulation du produit.
 Leggere le istruzioni prima di utilizzare il prodotto.
 Ler as instruções de uso antes de manusear o produto.

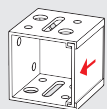

2x



2x



1x



4x



8x

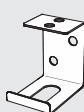

1x

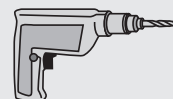

Ø 6 mm

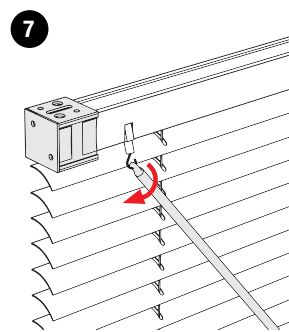
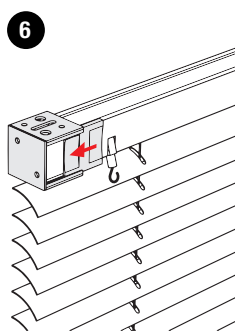
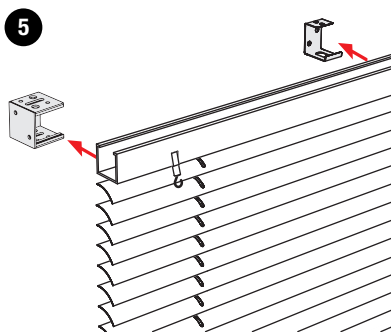
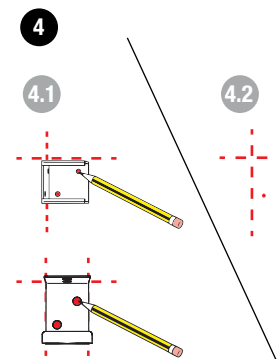
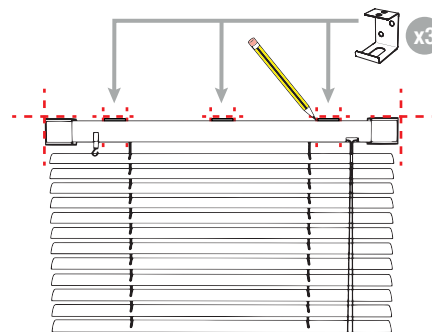
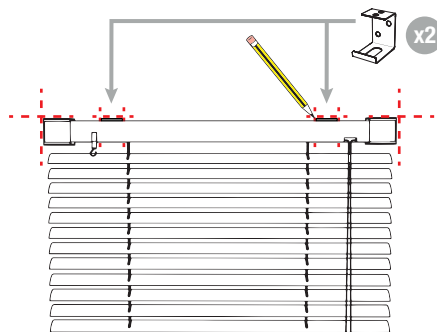
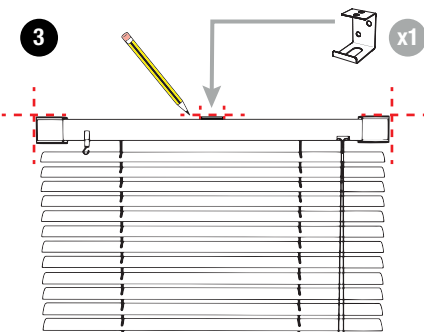
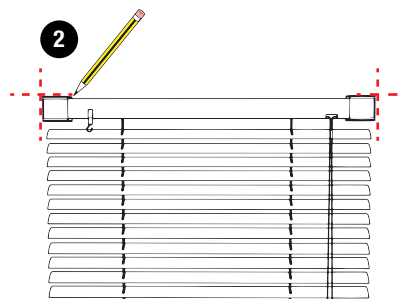
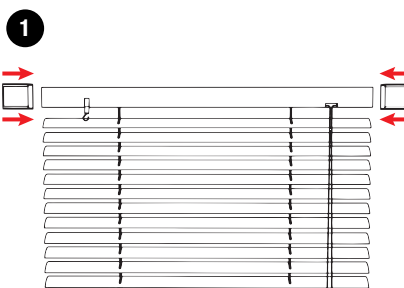
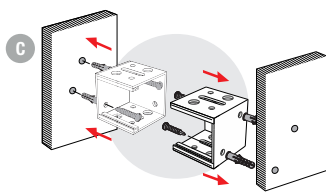
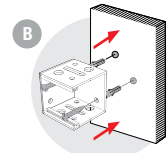
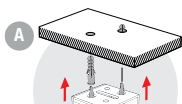

OPTIONAL

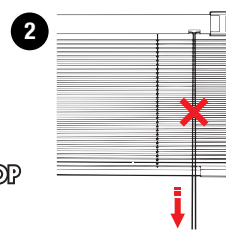
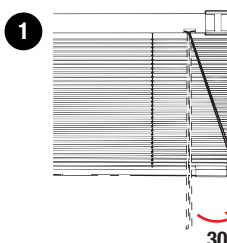
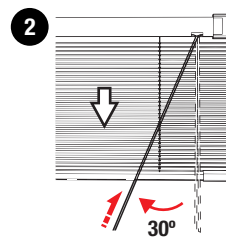
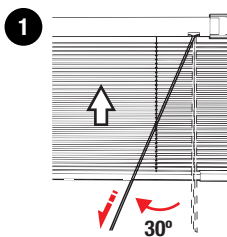
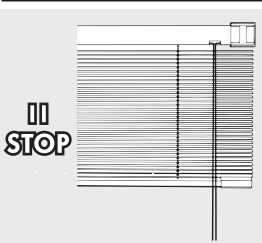
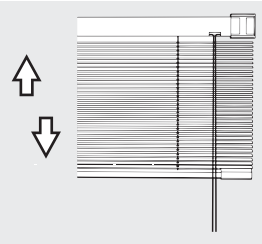
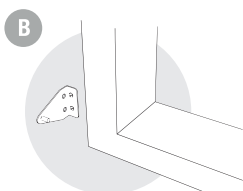
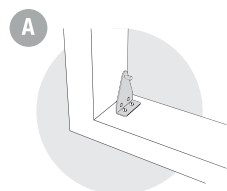
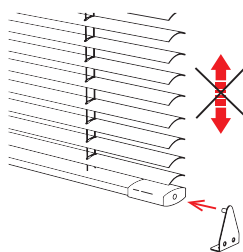

ADVERTENCIA-WARNING-ATTENTION-AVVERTENZA-AVISO

ESP Los niños pequeños pueden estrangularse debido a lazos en las cuerdas de estirado, cadenas, cintas y cuerdas interiores que maniobran el producto. Para evitar el estrangulamiento y el enmarañamiento de las cuerdas, manténgalas fuera del alcance de los niños pequeños. Las cuerdas pueden enredarse alrededor del cuello de un niño. Aleje camas, cunas y mobiliario de las cuerdas de la ventana. No entrelace las cuerdas. Asegúrese de que las cuerdas no se enreden y forman un lazo.

ENG Young children can strangle in the loop of pull cords, chains and tapes, cords and inner cords that operate window coverings. They can also wrap cords around their necks. To avoid strangulation and entanglement, keep cords out of the reach of young children. Move beds, cots and furniture away from window covering cords. Do not tie cords together. Make sure cords do not twist and create a loop.

FRA Les boucles des cordons de tirage, des chaînes et des rubans, ainsi que les cordons intérieurs actionnant les habillages de fenêtre, présentent un risque d'étranglement pour les jeunes enfants. Ces derniers peuvent aussi enrouler les cordons autour de leur cou. Pour éviter tout risque d'étranglement et d'enchevêtrement, tenir les cordons hors de portée des jeunes enfants. Déplacer les lits, les lits d'enfants, et les meubles se trouvant à proximité des cordons des habillages de fenêtre. Ne pas emmêler les cordons. Assurez-vous que les cordons ou chaînettes ne forment pas de boucles.

ITA I bambini possono rimanere strangolati negli anelli formati da cordini, catenelle, cordini interni e nastri di regolazione delle tende. I bambini possono anche avvolgersi i cordini intorno al collo. Per evitare il rischio di strangolamento e impigliamento, tenere i cordini fuori dalla portata dei bambini. Posizionare letti, lettini e altri mobili, lontano da questi elementi. Non interlacciare i cordini. Accertarsi che i cordini non formino un anello a groviglio.

POR Os cordões e as correntes, bem como os cordões e cordas internas que atravessam os estores, podem apresentar o perigo de estrangulamento para as crianças, já que estas podem enrolá-los à volta do pescoço. Para evitar o risco de estrangulamento, mantenha os cordões fora do alcance das crianças. Afaste os berços e restantes móveis dos cordões dos estores. Não entrelace as cordas. Assegure-se de que as cordas não se entrelaçam e formem um laço.

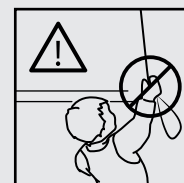

ESP Este producto cumple la normativa europea de seguridad infantil

ENG This product complies with European regulations on child safety.

FRA Ce produit est conforme aux réglementations européennes sur la sécurité des enfants.

ITA Questo prodotto è conforme alle normative europee sulla sicurezza dei bambini.

POR Este produto está em conformidade com os regulamentos europeus sobre segurança infantil.

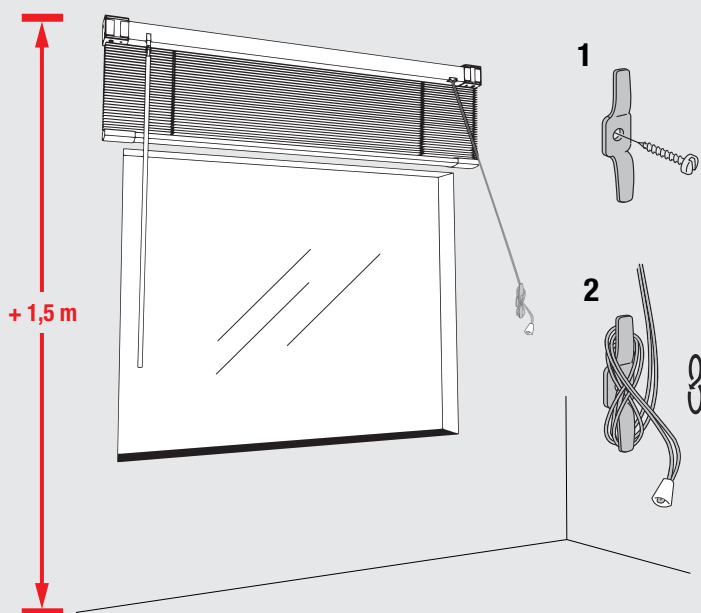

ESP El dispositivo fijo de retención debe instalarse a la máxima distancia posible respecto al mecanismo de control para evitar que la(s) cuerda(s) de estirado enlazada(s) quede(n) sin tensión. Los rails superiores no deben instalarse a menos de 1,5m del pavimento. El sistema de acumulación debe instalarse tan próximo al rail superior como sea posible, a no menos de 1,5m del pavimento.

ENG The fixed tensioning system should be installed as far as possible from the control mechanism to avoid the linked cord(s) coming loose. The upper rails must not be fitted less than 1.5 m from the floor. The accumulation system should be installed as close to the upper rail as possible, not less than 1.5 m from the floor.

FRA Le dispositif fixe de retenue doit être installé le plus loin possible du mécanisme de contrôle dans le but d'éviter que la (les) corde (s) de levage tressée (s) ne se retrouve (ent) sans tension. L'installation des rails supérieurs ne doit pas se faire à moins d'1,5 m du sol. L'installation du système d'accumulation doit être réalisée le plus près possible du rail supérieur et à au moins 1,5m du sol.

ITA Il dispositivo fisso di ritenuta deve essere installato a maggior distanza possibile dal meccanismo di controllo per evitare che le corde di tensione collegate non siano ben tese. I binari superiori devono essere installati a meno di 1,5 m dal pavimento. Il sistema di accumulo deve essere installato vicino al binario superiore se possibile, a meno di 1,5 m dal pavimento.

POR O dispositivo fixo de retenção deve ser instalado o mais afastado possível do mecanismo de controlo para evitar que o(s) cordão(ões) de tensionamento entrançado(s) fique(m) sem tensão. As calhas superiores não devem ser instaladas a menos de 1,5 m do solo. O sistema de acumulação deve ser instalado o mais próximo possível da calha superior, a uma distância mínima de 1,5 m do solo.

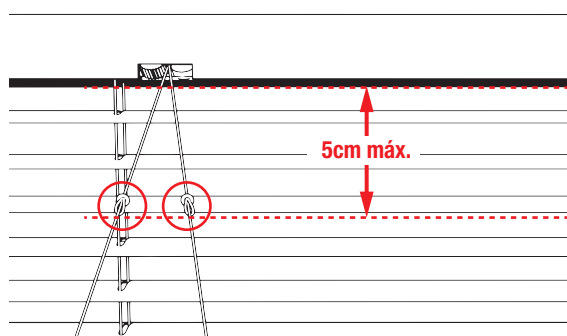

ESP Una parada de cuerda interna debe instalarse en cada cuerda de estirado tan próxima al rail superior como sea posible y a no más de 50mm, con la veneciana en la posición de extensión completa.

ENG An internal cord stop should be fitted to each cord as close to the upper rail as possible and not more than 50 mm away, with the blind completely extended.

FRA L'installation du système d'accumulation doit être réalisée le plus près possible du rail supérieur et à au moins 1,5m du sol.

ITA Occorre installare un'interruzione della corda in terna su ciascuna corda di tensione vicina al binario superiore se possibile e a una distanza massima di 50 mm, con la veneziana in posizione di completa estensione.

POR Em cada cordão de tensionamento deve ser instalado um travão de cordão interno, o mais próximo possível da calha superior e a uma distância máxima de 50 mm, com a veneziana na posição de extensão completa.