

# Cerraduras de pomo

TESA

ASSA ABLOY



# Especialistas y líderes en cerraduras de pomo



Más de 60 años fabricando cerraduras de pomo hacen que [TESA](#) sea un referente imprescindible en el mercado para el tipo de cerradura más extendido a nivel mundial: la cerradura de pomo, un producto fiable y muy cómodo de instalar, con infinitas posibilidades.

## Facilidad y sencillez en la instalación

Las cerraduras de pomo **TESA** son un producto muy sencillo de instalar. En 3 pasos podemos equipar una puerta y tenerla en perfecto funcionamiento.

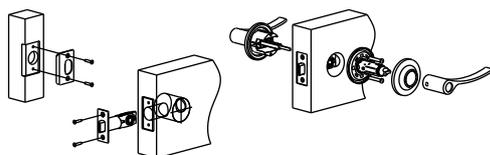

## Amplia gama de funciones y acabados

**TESA** principal fabricante europeo de cerraduras de pomo puede ofrecerle la más amplia gama de acabados y funciones que se requieran para cada caso. Puertas de paso libre, puertas que requieren privacidad, las que se desean controlar con llave, tiradores y un largo etc. siempre acordes a los requerimientos de acabados, han demostrado cumplir con creces las exigencias y necesidades del mercado. Acabados latonados, cromados, niquelados, negros, blancos ... cuidadosamente elaborados para que resistan años.



## Amaestramientos y cilindros de seguridad

¿Quiere control, comodidad y seguridad en una cerradura de pomo? No tenga duda en optar por amaestrarlos con nuestros cilindros de seguridad de llave plana. Un amaestramiento le permitirá con un número muy reducido de llaves (incluso sólo con una, si es necesario) y de forma muy cómoda, abrir más de una puerta, limitar el acceso de ciertas personas a determinadas puertas y contar con la seguridad que usted necesita.



## Reposición

La gran ventaja de las cerraduras de pomo es la posibilidad que nos ofrecen de cambiar y modernizar la estética de una puerta, el acabado o la función instalada en la misma, sin necesidad de tener que volver a mecanizar la puerta, sencillamente soltando una cerradura y colocando la que deseemos.



## Productos certificado

Además de un producto sencillo y fácil de instalar, las cerraduras de pomo **TESA** son productos de gran resistencia, con una fijación pasante y muy duradera. Así lo avalan los cumplimientos de normas **ANSI** y **UL** que corroboran su nivel de resistencia y su durabilidad incluso en situaciones de fuego.



## Garantías TESA

Comprar **TESA** es garantía de calidad. Las cerraduras de pomo **TESA** son productos de confianza total, cuya fabricación y diseño están avalados con las máximas garantías de calidad, respeto y cuidado del medioambiente que acreditan las certificaciones **ISO9001** e **ISO14001**, así como el de Seguridad en el Trabajo y Prevención de Riesgos Laborales.



# Indice acabados



Latón pulido  
LP

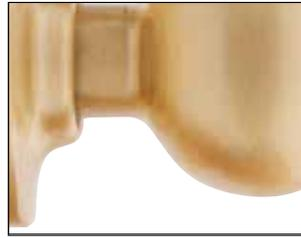

Latón mate  
LM



Cromo brillo  
CR

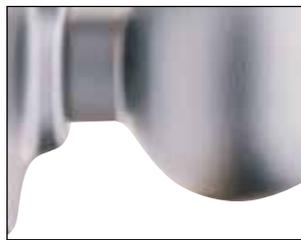

Cromo mate  
CM



Latón antiguo  
LA

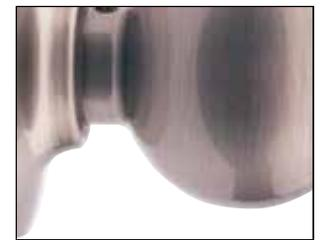

Níquel satinado  
NS



Marengo brillo  
MB



Blanco  
BL



Negro  
NE



Acero esmaltado  
AE

# Indice

## Contenido

<b>Sistemas cuadradillo</b>	<b>6</b>
Funciones	7
Modelos de manillas	8
Serie Flare 3F00	8
Serie Barcelona 3B00	9
Serie Arko 3A00	9
Serie Hermes 3H00	10
Serie Toledo 3T00	10
Serie Jerez 3J00	11
Serie Granada 3G00	11
Serie Bola 3900	12
Serie Tulipa 3500	13
Serie Nobel 3800	14
Serie California 3550	14
<b>Cerrojos</b>	<b>15</b>
Cerrojo 514	15
Cerrojo 517	15
Cerrojo 516	15
<b>Escudos embellecedores</b>	<b>16</b>
<b>Picaportes y cerraderos</b>	<b>17</b>
Picaporte cuadradillo	17
Cerrojo 516 y 517	17
Cerraderos	17
<b>Colección Access</b>	<b>18</b>
Normativa	19
Datos técnicos	20
Modelos	20
Funciones	21
Acabados	21
<b>Roseta 50 mm</b>	<b>23</b>
Coma	23
Luna	24
Mira	25
<b>Escudo 65 mm</b>	<b>26</b>
Coma	26
Luna	27
Mira	28



Sistema cuadradillo



Cerrojos



Escudos embellecedores



Picaportes y cerraderos



Colección ACCESS

# Sistemas cuadradillo

## Ventajas al cuadrado

- » Mecanismo multifuncional que sirve tanto para pomo como para manilla, de gran robustez de componentes y accionamiento muy suave.
- » Es aplicable a edificios institucionales de alto tráfico de personas y edificios residenciales de tráfico medio.

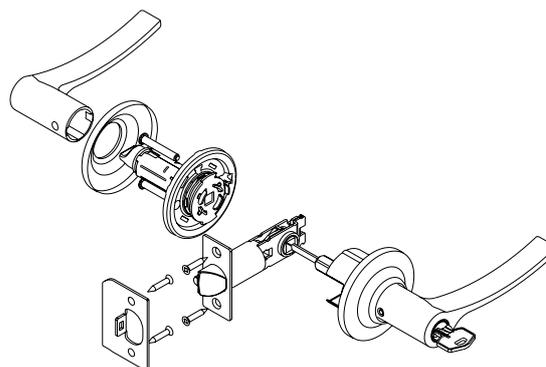
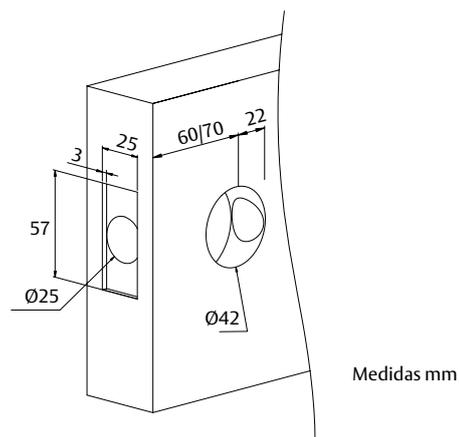

Características	Estandar	Especial
Características técnicas	Picaporte con dispositivo de seguridad antitarjeta en funciones 0, 1 y 2	Función antipánico: en puertas condenadas con llave, el interior siempre es de accionamiento libre
Resistencia anti-corrosión s/ASTM B 117/90	CR,CM,NS ....144 horas LP,LM ..... 96 horas	
Espesor puerta	33-45 mm manillas 33-52 mm pomos Salvo función 07: 40-50mm	Hasta 75 mm
ANSI A156.2	Grado 2: 400.000 ciclos	
UL		Hasta 1,5 horas de exposición al fuego
Cilindro	5 pitones activos y 3 llaves	Cilindro de seguridad: T60, T80, TX80, T10, T12 Llaves iguales y amaestramietnos
Picaporte	Entrada 60 ó 70 mm - unificado Saliente 12,5 mm	127 mm Frente redondeado
Accesorios	Cerradero, tornillos, instrucciones y plantilla de montaje	Cerradero redondeado
Uds. embalaje	20	
Reversibilidad	Todos los pomos son reversibles - Ojo con las manos de algunas manillas	

# Sistemas cuadradillo

## Funciones

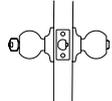
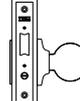
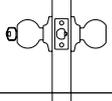
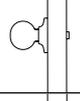
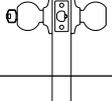
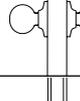
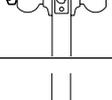
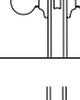
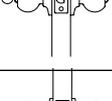
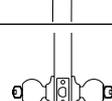
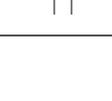
Función	Descripción	Función	Descripción
	00 ENTRADA: ambos lados son condenados y descondenados por la llave exterior o la muletilla interior.		20 ENTRADA: condena y descondena por la llave exterior y el pomo interior. Picaporte-palanca. Aplicable a portero automático.
	01 ENTRADA: condena y descondena sólo por la llave exterior. El interior queda condenado.		31 TIRADOR FIJO: fijación pasante desde el interior.
	01AP ENTRADA: condena y descondena sólo por la llave exterior. Desde el interior siempre se puede abrir.		32 DOBLE TIRADOR FIJO
	02 AULAS: el exterior fijo, sólo se abre con llave. El interior siempre se puede abrir.		33 ENTRADA: ambos lados siempre libres, aplicable a cerraduras de embutir. No incluye cerradura.
	03 BAÑOS Y DORMITORIOS: ambos lados son condenados y descondenados por la muletilla interior. Posibilidad de descondena exterior mediante dispositivo de emergencia.		34 ENTRADA: siempre libre, aplicable a cerraduras de embutir. No incluye cerradura.
	05 PUERTAS DE PASO: ambos lados siempre libres.		
	07 OFICINAS: la llave condena y descondena cada lado de forma independiente. La condena no se transmite de un lado a otro de la puerta. Espesor de hoja: 40-50mm		

## Interpretación del código

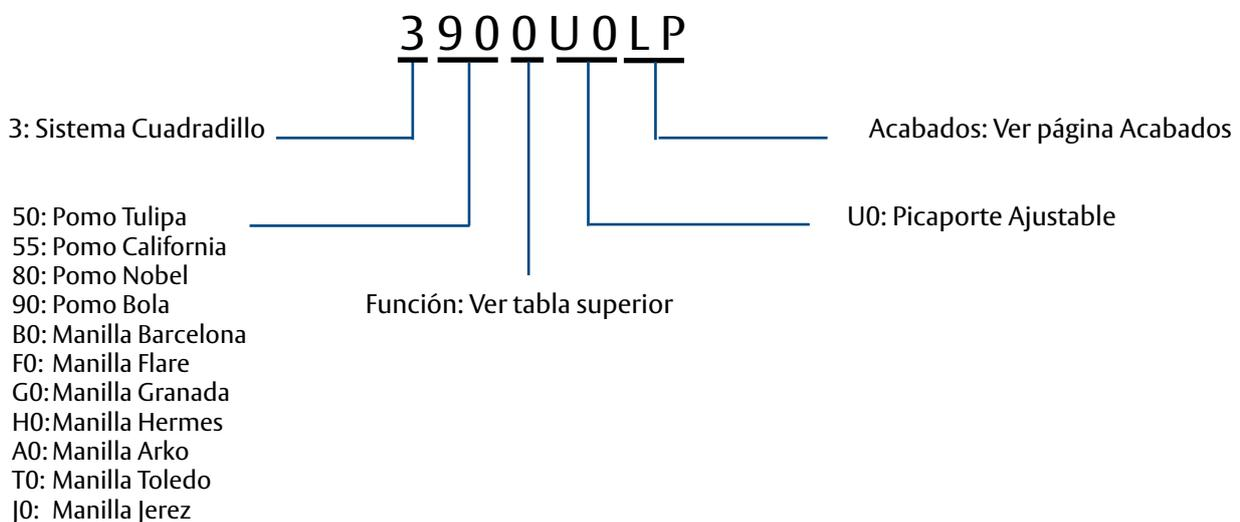

# Sistema cuadradillo

## Modelos de manillas

Modelo	A	B	C
Arko	65	62	112
Barcelona	65	62	109
Flare	65	62	107
Granada	65	62	119

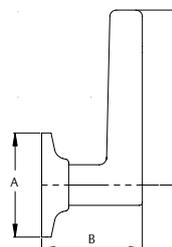

3A00 Arko                      3B00 Barcelona



3H00 Hermes                      3J00 Jerez



3F00 Flare                      3G00 Granada



3T00 Toledo



## Serie Flare 3F00

Entrada	Función	Entrada	Acabado	Embalaje
	3F00	U0	CM - CR - LM - LP - NS LA - BL - NE	20

Aula	Función	Entrada	Acabado	Embalaje
	3F02D	U0	CM - CR - LM - LP - NS LA - BL - NE	20

Aula	Función	Entrada	Acabado	Embalaje
	3F02I	U0	CM - CR - LM - LP - NS LA - BL - NE	20

Baño	Función	Entrada	Acabado	Embalaje
	3F03	U0	CM - CR - LM - LP - NS LA - BL - NE	20

Paso	Función	Entrada	Acabado	Embalaje
	3F05	U0	CM - CR - LM - LP - NS LA - BL - NE	20

Oficina	Función	Entrada	Acabado	Embalaje
	3F07	U0	CM - CR - LM - LP - NS LA - BL - NE	20

Pomo - cuadradillo	Función	Entrada	Acabado	Embalaje
	3F34D	00	CM - CR - LM - LP - NS LA - BL - NE	20

Pomo - cuadradillo	Función	Entrada	Acabado	Embalaje
	3F34I	00	CM - CR - LM - LP - NS LA - BL - NE	20

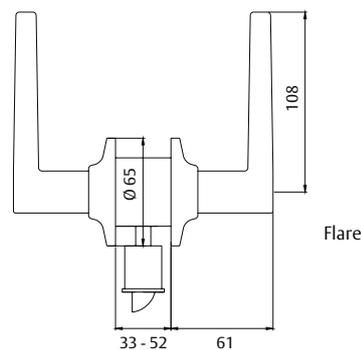

# Sistema cuadradillo

## Serie Barcelona 3B00

Entrada	Función	Entrada	Acabado	Embalaje
	3B00	U0	CM - CR - LM - LP - NS LA - BL - NE	20
Aula	Función	Entrada	Acabado	Embalaje
	3B02D	U0	CM - CR - LM - LP - NS LA - BL - NE	20
Aula	Función	Entrada	Acabado	Embalaje
	3B02I	U0	CM - CR - LM - LP - NS LA - BL - NE	20
Baño	Función	Entrada	Acabado	Embalaje
	3B03	U0	CM - CR - LM - LP - NS LA - BL - NE	20
Paso	Función	Entrada	Acabado	Embalaje
	3B05	U0	CM - CR - LM - LP - NS LA - BL - NE	20
Oficina	Función	Entrada	Acabado	Embalaje
	3T07	U0	CM - CR - LM - LP - NS LA - BL - NE	20
Pomo - cuadradillo	Función	Entrada	Acabado	Embalaje
	3B34D	00	CM - CR - LM - LP - NS LA - BL - NE	20
Pomo - cuadradillo	Función	Entrada	Acabado	Embalaje
	3B34I	00	CM - CR - LM - LP - NS LA - BL - NE	20

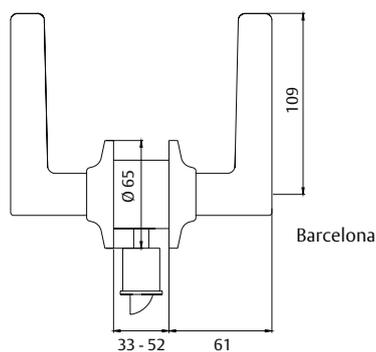

## Serie Arko 3A00

Entrada	Función	Entrada	Acabado	Embalaje
	3A00	U0	CM - CR - LM - LP - NS LA - BL - NE	20
Aula	Función	Entrada	Acabado	Embalaje
	3A02D	U0	CM - CR - LM - LP - NS LA - BL - NE	20
Aula	Función	Entrada	Acabado	Embalaje
	3A02I	U0	CM - CR - LM - LP - NS LA - BL - NE	20
Baño	Función	Entrada	Acabado	Embalaje
	3A03	U0	CM - CR - LM - LP - NS LA - BL - NE	20
PAso	Función	Entrada	Acabado	Embalaje
	3A05	U0	CM - CR - LM - LP - NS LA - BL - NE	20
Oficina	Función	Entrada	Acabado	Embalaje
	3A07	U0	CM - CR - LM - LP - NS LA - BL - NE	20
Pomo - cuadradillo	Función	Entrada	Acabado	Embalaje
	3A34D	00	CM - CR - LM - LP - NS LA - BL - NE	20
Pomo - cuadradillo	Función	Entrada	Acabado	Embalaje
	3A34I	00	CM - CR - LM - LP - NS LA - BL - NE	20

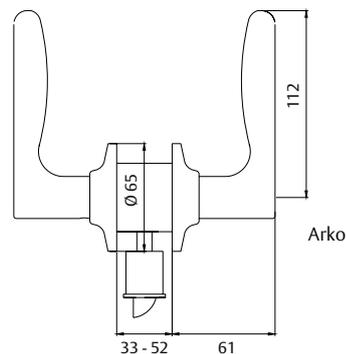

# Sistema cuadradillo

## Serie Hermes 3H00

Entrada	Función	Entrada	Acabado	Embalaje
	3H00	U0	CM - CR - LM - LP - NS LA - BL - NE	20
Aula	Función	Entrada	Acabado	Embalaje
	3H02D	U0	CM - CR - LM - LP - NS LA - BL - NE	20
Aula	Función	Entrada	Acabado	Embalaje
	3H02I	U0	CM - CR - LM - LP - NS LA - BL - NE	20
Baño	Función	Entrada	Acabado	Embalaje
	3H03	U0	CM - CR - LM - LP - NS LA - BL - NE	20
Paso	Función	Entrada	Acabado	Embalaje
	3H05	U0	CM - CR - LM - LP - NS LA - BL - NE	20
Oficina	Función	Entrada	Acabado	Embalaje
	3H07	U0	CM - CR - LM - LP - NS LA - BL - NE	20
Pomo - cuadradillo	Función	Entrada	Acabado	Embalaje
	3H34D	00	CM - CR - LM - LP - NS LA - BL - NE	20
Pomo - cuadradillo	Función	Entrada	Acabado	Embalaje
	3H34I	00	CM - CR - LM - LP - NS LA - BL - NE	20

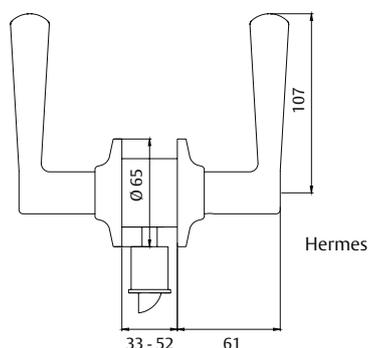

## Serie Toledo 3T00

Entrada	Función	Entrada	Acabado	Embalaje
	3T00	U0	CM - CR - LM - LP - NS LA - BL - NE	20
Aula	Función	Entrada	Acabado	Embalaje
	3T02	U0	CM - CR - LM - LP - NS LA - BL - NE	20
Baño	Función	Entrada	Acabado	Embalaje
	3T03	U0	CM - CR - LM - LP - NS LA - BL - NE	20
Paso	Función	Entrada	Acabado	Embalaje
	3T05	U0	CM - CR - LM - LP - NS LA - BL - NE	20
Oficina	Función	Entrada	Acabado	Embalaje
	3T07	U0	CM - CR - LM - LP - NS LA - BL - NE	20
Pomo - cuadradillo	Función	Entrada	Acabado	Embalaje
	3T34	00	CM - CR - LM - LP - NS LA - BL - NE	20

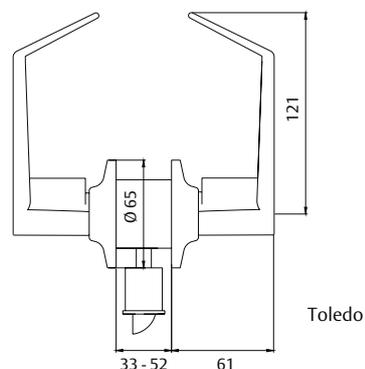

# Sistema cuadradillo

## Serie Jerez 3J00

Entrada	Función	Entrada	Acabado	Embalaje
	3J00	U0	CM - CR - LM - LP - NS LA - BL - NE	20
Aula	Función	Entrada	Acabado	Embalaje
	3J02	U0	CM - CR - LM - LP - NS LA - BL - NE	20
Baño	Función	Entrada	Acabado	Embalaje
	3J03	U0	CM - CR - LM - LP - NS LA - BL - NE	20
Paso	Función	Entrada	Acabado	Embalaje
	3J05	U0	CM - CR - LM - LP - NS LA - BL - NE	20
Oficina	Función	Entrada	Acabado	Embalaje
	3J07	U0	CM - CR - LM - LP - NS LA - BL - NE	20
Pomo - cuadradillo	Función	Entrada	Acabado	Embalaje
	3J34	00	CM - CR - LM - LP - NS LA - BL - NE	20

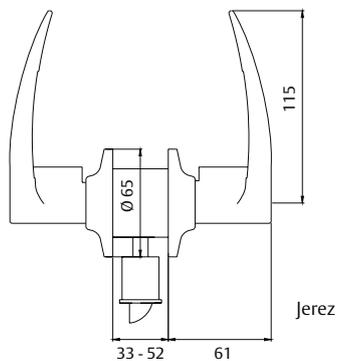

## Serie Granada 3G00

Entrada	Función	Entrada	Acabado	Embalaje
	3G00	U0	CM - CR - LM - LP - NS LA - BL - NE	20
Aula	Función	Entrada	Acabado	Embalaje
	3G02	U0	CM - CR - LM - LP - NS LA - BL - NE	20
Baño	Función	Entrada	Acabado	Embalaje
	3G03	U0	CM - CR - LM - LP - NS LA - BL - NE	20
Paso	Función	Entrada	Acabado	Embalaje
	3G05	U0	CM - CR - LM - LP - NS LA - BL - NE	20
Oficina	Función	Entrada	Acabado	Embalaje
	3G07	U0	CM - CR - LM - LP - NS LA - BL - NE	20
Pomo - cuadradillo	Función	Entrada	Acabado	Embalaje
	3G34	00	CM - CR - LM - LP - NS LA - BL - NE	20

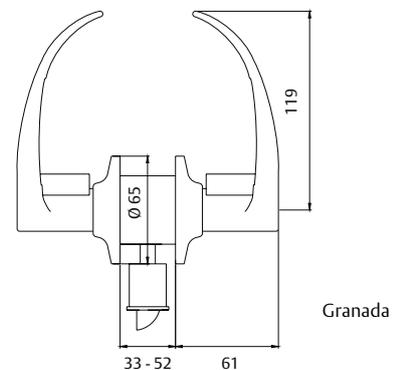

# Sistema cuadradillo

## Serie Bola 3900

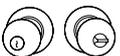
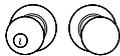
Entrada	Modelo	Entrada	Acabado	Embalaje
	3900	U0 UV	CM - CR - LM - LP - NS LA - BL - NE - AE	20
Puertas a condonar	Modelo	Entrada	Acabado	Embalaje
	3901	U0	CM - CR - LM - LP - NS LA - BL - NE - AE	20
Aula	Modelo	Entrada	Acabado	Embalaje
	3901AP	U0	CCM - CR - LM - LP - NS LA - BL - NE - AE	20
Aula	Modelo	Entrada	Acabado	Embalaje
	3902	U0	CM - CR - LM - LP - NS LA - BL - NE - AE	20
Baño	Modelo	Entrada	Acabado	Embalaje
	3903	U0 UV	CM - CR - LM - LP - NS LA - BL - NE - AE	20
Paso	Modelo	Entrada	Acabado	Embalaje
	3905	U0 UV	CM - CR - LM - LP - NS LA - BL - NE - AE	20

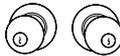
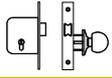
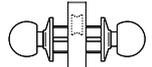
Oficina	Modelo	Entrada	Acabado	Embalaje
	3907	U0	CM - CR - LM - LP - NS LA - BL - NE - AE	20
Entrada	Modelo	Entrada	Acabado	Embalaje
	3920	50	CM - CR - LM - LP - NS LA - BL - NE - AE	20
Pomo tirador	Modelo	Entrada	Acabado	Embalaje
	3931	00	CM - CR - LM - LP - NS LA - BL - NE - AE	20
Doble tirador	Modelo	Entrada	Acabado	Embalaje
	3932	00	CM - CR - LM - LP - NS LA - BL - NE - AE	20
Doble cuadradillo	Modelo	Entrada	Acabado	Embalaje
	3933	00	CM - CR - LM - LP - NS LA - BL - NE - AE	20
Pomo - cuadradillo	Modelo	Entrada	Acabado	Embalaje
	3934	00	CM - CR - LM - LP - NS LA - BL - NE - AE	20

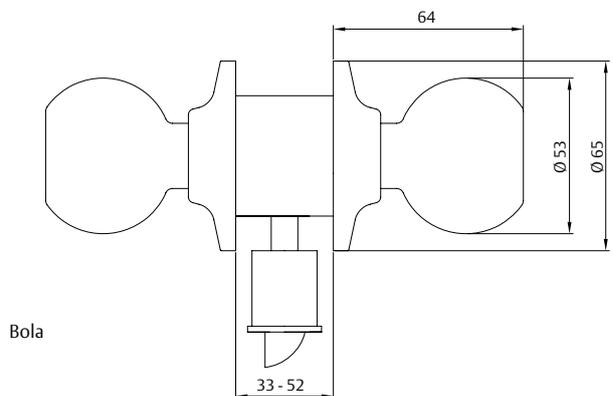

# Sistema cuadradillo

## Serie Tulipa 3500

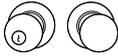
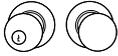
Entrada	Modelo	Entrada	Acabado	Embalaje
	3500	U0 UV	CM - CR - LM - LP - NS LA - BL - NE - AE	20
Puertas a condonar	Modelo	Entrada	Acabado	Embalaje
	3501	U0	CM - CR - LM - LP - NS LA - BL - NE - AE	20
Aula	Modelo	Entrada	Acabado	Embalaje
	3501AP	U0	CM - CR - LM - LP - NS LA - BL - NE - AE	20
Aula	Modelo	Entrada	Acabado	Embalaje
	3502	U0	CM - CR - LM - LP - NS LA - BL - NE - AE	20
Baño	Modelo	Entrada	Acabado	Embalaje
	3503	U0 UV	CM - CR - LM - LP - NS LA - BL - NE - AE	20
Paso	Modelo	Entrada	Acabado	Embalaje
	3505	U0 UV	CM - CR - LM - LP - NS LA - BL - NE - AE	20

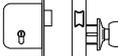
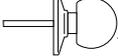
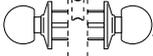
Oficina	Modelo	Entrada	Acabado	Embalaje
	3507	U0	CM - CR - LM - LP - NS LA - BL - NE - AE	20
Entrada	Modelo	Entrada	Acabado	Embalaje
	3520	U0	CM - CR - LM - LP - NS LA - BL - NE - AE	20
Pomo tirador	Modelo	Entrada	Acabado	Embalaje
	3531	U0	CM - CR - LM - LP - NS LA - BL - NE - AE	20
Doble tirador	Modelo	Entrada	Acabado	Embalaje
	3532	U0	CM - CR - LM - LP - NS LA - BL - NE - AE	20
Doble cuadradillo	Modelo	Entrada	Acabado	Embalaje
	3533	U0	CM - CR - LM - LP - NS LA - BL - NE - AE	20
Pomo - cuadradillo	Modelo	Entrada	Acabado	Embalaje
	3534	U0	CM - CR - LM - LP - NS LA - BL - NE - AE	20

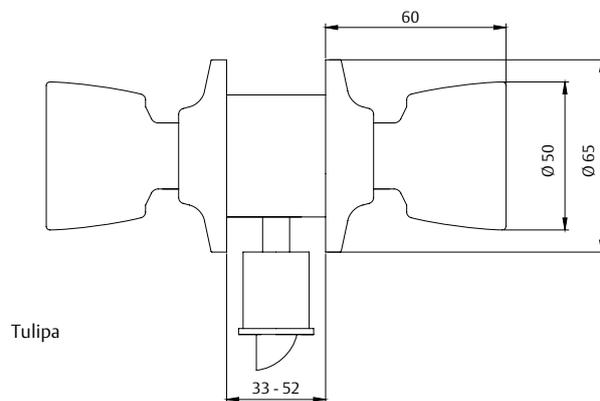

# Sistema cuadradillo

## Serie Nobel 3800

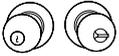
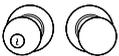
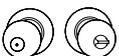
Entrada	Modelo	Entrada	Acabado	Embalaje
	3800	U0	CM - CR - LM - LP - NS LA	20
Aula	Modelo	Entrada	Acabado	Embalaje
	3802	U0	CM - CR - LM - LP - NS LA	20
Baños	Modelo	Entrada	Acabado	Embalaje
	3803	U0	CM - CR - LM - LP - NS LA	20
Paso	Modelo	Entrada	Acabado	Embalaje
	3805	U0	CM - CR - LM - LP - NS LA	20

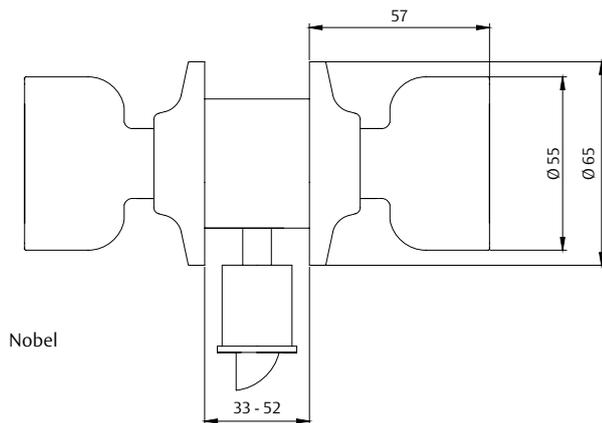

## Serie California 3550

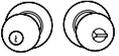
Entrada	Modelo	Entrada	Acabado	Embalaje
	3550	U0	CM - CR - LM - LP - NS LA	20
Aula	Modelo	Entrada	Acabado	Embalaje
	3552	U0	CM - CR - LM - LP - NS LA	20
Baños	Modelo	Entrada	Acabado	Embalaje
	3553	U0	CM - CR - LM - LP - NS LA	20
Paso	Modelo	Entrada	Acabado	Embalaje
	3555	U0	CM - CR - LM - LP - NS LA	20

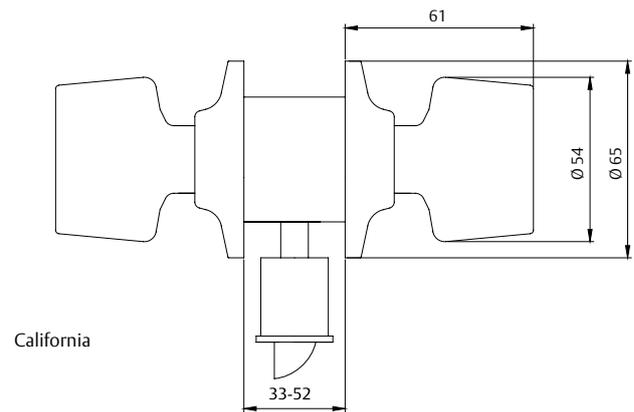

# Cerrojos

## Cerrojo 514

- » Cerraduras auxiliares para complemento de cerraduras de pomo.
- » Aplicable a edificios institucionales y residenciales.
- » Cerrojo con accionamiento único ADA desde el interior, que facilita su apertura. Fijación interior no pasante.

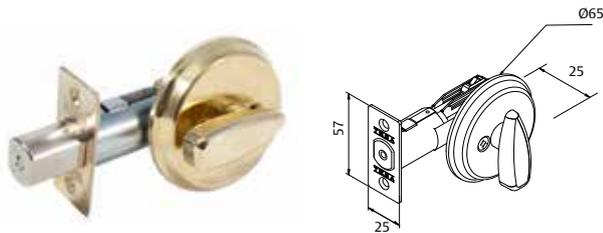

Modelo	Entrada	Acabado	Embalaje
514	U0	CM - CR - LM - LP - NS - LA	20

## Cerrojo 516

- » Cerraduras auxiliares para complemento de cerraduras de pomo.
- » Aplicable a edificios institucionales y residenciales.
- » Cerrojo con llave exterior y muletilla ADA interior, que facilita su apertura.

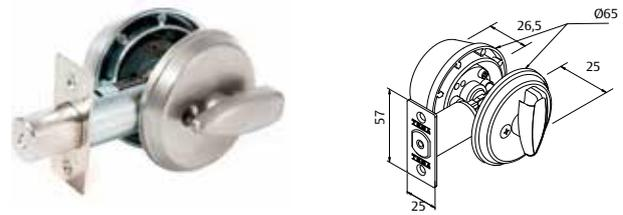

Modelo	Entrada	Acabado	Embalaje
516	U0	CM - CR - LM - LP - NS - LA	20

## Cerrojo 517

- » Cerrojo con llave en el exterior y el interior.

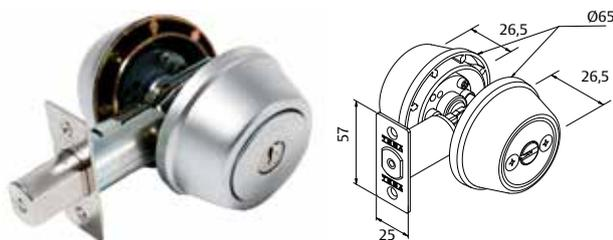

Modelo	Entrada	Acabado	Embalaje
517	U0	CM - CR - LM - LP - LA - NS	20

Características	Estandar	Especial
Resistencia anti-corrosión s/ASTM B 117/90	CR, CM ... 144 horas LP, LM ... 96 horas	
Espesor puerta	33-47 mm en 514 33-52 mm en 516, 517	Hasta 72 mm en 514 Hasta 70 mm en 516
ANSI A156.2	Grado 3: 100.000 ciclos	
UL	ANSI A156.5	Hasta 1,5 horas de exposición al fuego
Muletilla	ADA que facilita el accionamiento	
Cilindro	5 pitones activos y 3 llaves	Cilindro de seguridad: T60, T80, TX80 Llaves iguales y amaestramientos
Picaporte	Entrada 60 ó 70 mm - unificado y con dispositivo antisierra	
Accesorios	Cerradero, tornillos, instrucciones y plantilla de montaje	Cerradero redondeado
Uds. embalaje	20	

# Escudos embellecedores

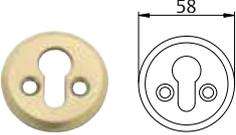
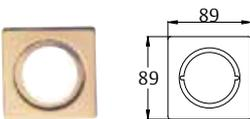
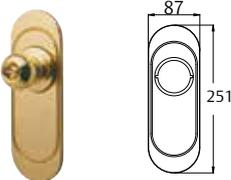
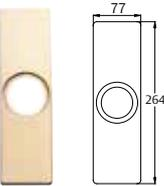
Modelo 461 / 45	Acabado	Embalaje	Modelo 452 / 90	Acabado	Embalaje
	CM - CR - LM - LP NS - LN	10		CM - LM - LP	10
Modelo 469 / ED	Acabado	Embalaje	Modelo 453 / 26	Acabado	Embalaje
	CM - LM - LP	10		CM - LM - LP	10

\* No se realizan bocallaves.

\* No se realizan bocallaves.

# Picaportes y cerraderos

## Picaporte cuadradillo

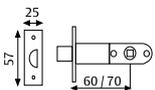
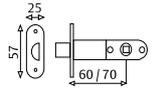
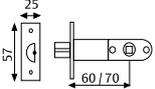
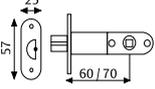
Estándar	Modelo	Acabado	Medida	Embalaje
	P030U0	LP - CR	60/70	200
	P03020	LP - CR	127	100
Redondo 1/2	Modelo	Acabado	Medida	Embalaje
	P030U2	LP - CR	60/70	200
Dispositivo seguridad	Modelo	Acabado	Medida	Embalaje
	P031U0	LP - CR	60/70	200
	P03120	LP - CR	127	100
Disp. seg. y redondo 1/2	Modelo	Acabado	Medida	Embalaje
	P031U2	LP - CR	60/70	200

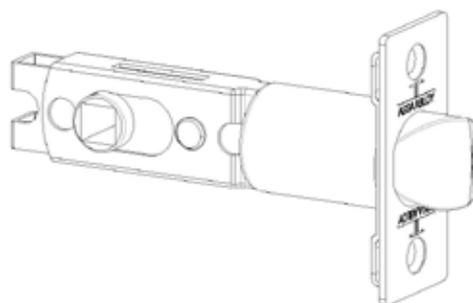

E

## Cerrojo 516 y 517

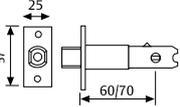
Estándar	Modelo	Acabado	Medida	Embalaje
	P016U0	LP - CR	60/70	200

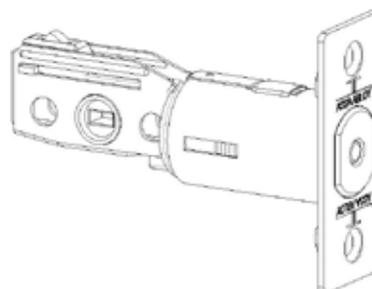

## Cerraderos

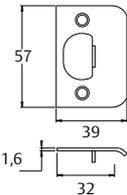
Estándar con solapa	Modelo	Acabado	Embalaje
	C2500	HL	800
	C2500	HN	800

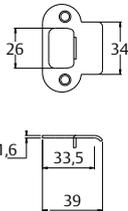
Redondeado 1/2 con solapa	Modelo	Acabado	Embalaje
	CR25 / 34	HL	1000
	CR25 / 34	HN	1000



# Colección Access



Las formas de acceso cambian. Se transforman. Evolucionan. Por ello, [TESA](#) lanza su nueva Colección Access. Una serie con un diseño de vanguardia destinada a revolucionar el mundo de los

accesos gracias a sus diferentes modelos. Absolutamente exclusivos, originales, diferentes. Un medio de acceso tradicional que ofrece nuevas y espectaculares aplicaciones.

## Clasificación ANSI A 156.2:1996 y UNE - EN 12209: 2003

El American National Standard Institute (ANSI), para facilitar la diferenciación en seguridad, resistencia y funcionamiento, establece tres grados para las cerraduras de puerta. Estos grados (grado 1, 2 y 3, siendo el 1 el más alto) permiten al usuario elegir el producto que más se adecua a sus necesidades de funcionamiento y seguridad.



La norma europea UNE-EN 12209 especifica los requisitos y métodos de ensayo relativos a la durabilidad, resistencia, seguridad y funcionamiento de cerraduras y picaportes accionados mecánicamente para su utilización en puertas.



Para que una cerradura sea certificado con una u otra norma, debe superar unas rigurosas pruebas, que medirán:

- » El funcionamiento: fuerzas máximas necesarias para retirar el picaporte con el pomo, con la llave, para cerrar la puerta; proyección mínima del picaporte, ...
- » La resistencia: a la torsión con el pomo condensado; a esfuerzos horizontales y verticales sobre el pomo; resistencia del picaporte mientras se golpea la puerta, ...

- » El material con el que está fabricado: resistencia del material a deformaciones por golpes, ...
- » El acabado: resistencia del acabado en ensayos de niebla salina; a los rayos UVA, a ensayos de dureza y rayado; a ensayos de sudoración.

E

### Durabilidad

Llegan a superar los 400.000 ciclos o accionamientos.  
UNE-EN 12209: el máximo exigido por esta norma son 200.000.  
ANSI A 156.2: grado 2.

### Resistencia al esfuerzo vertical y lateral

Superior a 150 Kg.  
UNE-EN 12209: el máximo exigido por esta norma para todo tipo de cerraduras.  
ANSI A 156.2: exige 115 Kg. para cumplir el grado 2.

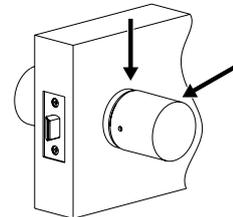

Todas las cotas están expresadas en mm.

### Par de accionamiento con el pomo condensado

Superior a 35 Nm.  
UNE-EN 12209: el máximo exigido por esta norma es 15Nm.  
ANSI A 156.2: exige 17 Nm para cumplir el grado 2.

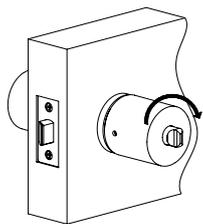

### Resistencia a tiro

Superior a 150 Kg.  
UNE-EN 12209: el máximo exigido por esta norma para todo tipo de cerraduras.  
ANSI A 156.2: exige 138 Kg. para cumplir el grado 2.

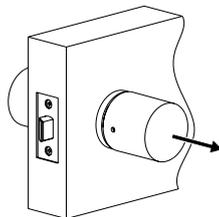

## Datos técnicos

Características	Estandar	Especial
Mecanismo	Altamente resistente, de apertura muy suave	
Aplicación	Edificios institucionales de alto tráfico de personas Edificios residenciales de tráfico medio	
Características técnicas	Picaporte con dispositivo de seguridad antitarjeta en funciones 0 y 2	
Resistencia anticorrosión s/ASTMB117/90	CR, CM, NS: 144 horas LP, LM: 96 horas	
Espesor puerta	33 - 45 mm Salvo función 07: 40-50 mm	Hasta 60 mm con roseta 50 mm Hasta 75 mm con escudo 65 mm
Escudo	50 mm de diámetro 65 mm de diámetro	
ANSI A156.2	Grado2: 400.000 ciclos	
UL		Certificable hasta 1,5 horas de exposición al fuego
Cilindro	5 pitones activos y 3 llaves	Cilindro de seguridad: T60, T80, TX80 Llaves iguales
Picaporte	Entrada 60 ó 70 mm - unificado Saliente 12,5 mm	127 mm Frente redondeado
Accesorios	Cerradero, tornillos, instrucciones y plantilla de montaje	Cerradero redondeado
Uds. embalaje	20	

## Modelos

Modelo	A	B	C
Coma	50 / 65	60	50
Luna	50 / 65	60	50
Mira	50 / 65	60	50

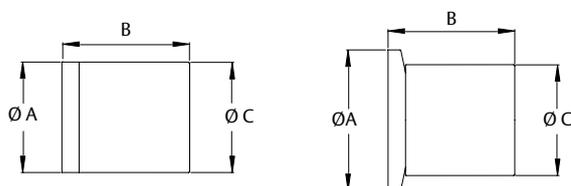

# Colección Access

## Funciones

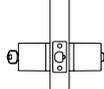
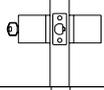
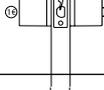
Función	Descripción
 00	ENTRADA: ambos lados son condenados y descondenados por la llave exterior o la muletilla interior.
 02	AULA: el exterior fijo, sólo se abre con llave. El interior siempre se puede abrir
 03	BAÑO: ambos lados son condenados y descondenados por la muletilla (modelos con escudo de 65mm) o el pulsador (modelos con roseta de 50mm) interior. Posibilidad de descondena exterior mediante dispositivo de emergencia.
 05	PUERTAS DE PASO: ambos lados siempre libres.
 07	OFICINAS: La llave condensa y descondena cada lado de forma independiente. No se transmite de un lado a otro de la puerta. Espesor de puerta: 40-50 mm.

Función	Descripción
 31	TIRADOR FIJO: fijación pasante desde el interior.
 32	DOBLE TIRADOR FIJO
 33	ENTRADA: ambos lados siempre libres, aplicable a cerraduras de embutir.
 34	ENTRADA: siempre libre, aplicable a cerraduras de embutir.

## Acabados



LP - Latón Pulido



LM - Latón Mate



CM - Cromo Mate



CR - Cromo Brillo



NS - Niquel Satinado

# Puertas de madera y metálicas

Se adaptan a cualquier tipo de puerta, con diferentes opciones. Con dos sencillos mecanizados en el frente y en la hoja de la puerta, y un montaje rápido, puertas de madera y metálicas quedan perfectamente equipadas. Incluso en el caso de puertas previamente mecanizadas, desmontar la cerradura anterior y montar la nueva será suficiente para conseguir renovar la imagen de nuestras puertas.



Coma 



Luna 

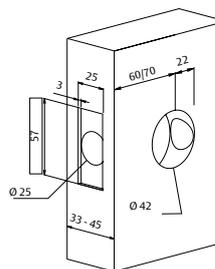

Mira 

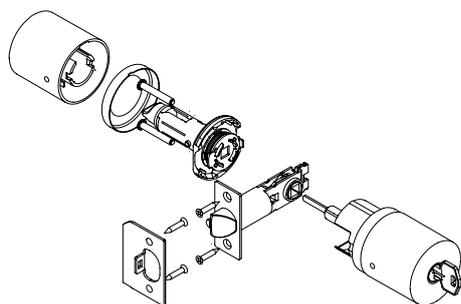
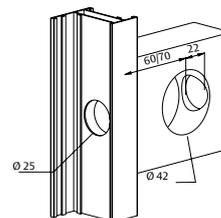

Roseta 50mm

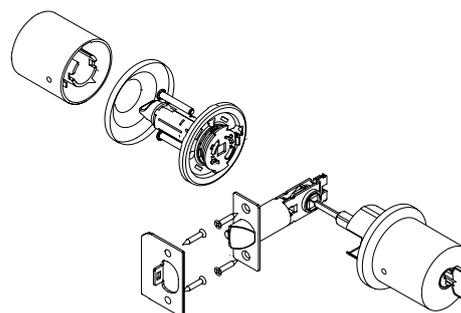

Escudo 65mm para reposición

# Puertas de madera y metálicas: roseta 50 mm

Coma 

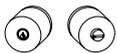
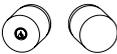
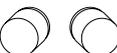
Entrada	Modelo	Mano	Entrada	Acabado	Embalaje
	3C00R	-	U0	LP	20
	3C00R	-	U0	LM	20
	3C00R	-	U0	CM	20
	3C00R	-	U0	CR	20
	3C00R	-	U0	NS	20
Aula	Modelo	Mano	Entrada	Acabado	Embalaje
	3C02R	D/I	U0	LP	20
	3C02R	D/I	U0	LM	20
	3C02R	D/I	U0	CM	20
	3C02R	D/I	U0	CR	20
	3C02R	D/I	U0	NS	20
Baño	Modelo	Mano	Entrada	Acabado	Embalaje
	3C03R	-	U0	LP	20
	3C03R	-	U0	LM	20
	3C03R	-	U0	CM	20
	3C03R	-	U0	CR	20
	3C03R	-	U0	NS	20
Paso	Modelo	Mano	Entrada	Acabado	Embalaje
	3C05R	-	U0	LP	20
	3C05R	-	U0	LM	20
	3C05R	-	U0	CM	20
	3C05R	-	U0	CR	20
	3C05R	-	U0	NS	20

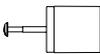
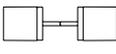
Oficinas	Modelo	Mano	Entrada	Acabado	Embalaje
	3C07R	-	U0	LP	20
	3C07R	-	U0	LM	20
	3C07R	-	U0	CM	20
	3C07R	-	U0	CR	20
	3C07R	-	U0	NS	20
Tirador	Modelo	Mano	Entrada	Acabado	Embalaje
	3C31R	D/I	00	LP	20
	3C31R	D/I	00	LM	20
	3C31R	D/I	00	CM	20
	3C31R	D/I	00	CR	20
	3C31R	D/I	00	NS	20
Doble tirador	Modelo	Mano	Entrada	Acabado	Embalaje
	3C32R	-	00	LP	20
	3C32R	-	00	LM	20
	3C32R	-	00	CM	20
	3C32R	-	00	CR	20
	3C32R	-	00	NS	20
Doble cuadradillo	Modelo	Mano	Entrada	Acabado	Embalaje
	3C33R	-	00	LP	20
	3C33R	-	00	LM	20
	3C33R	-	00	CM	20
	3C33R	-	00	CR	20
	3C33R	-	00	NS	20
Cuadradillo	Modelo	Mano	Entrada	Acabado	Embalaje
	3C34R	D/I	00	LP	20
	3C34R	D/I	00	LM	20
	3C34R	D/I	00	CM	20
	3C34R	D/I	00	CR	20
	3C34R	D/I	00	NS	20



# Puertas de madera y metálicas: roseta 50 mm

Luna 

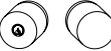
Entrada	Modelo	Mano	Entrada	Acabado	Embalaje
	3L00R	-	U0	LP	20
	3L00R	-	U0	LM	20
	3L00R	-	U0	CM	20
	3L00R	-	U0	CR	20
	3L00R	-	U0	NS	20
Aula	Modelo	Mano	Entrada	Acabado	Embalaje
	3L02R	D/I	U0	LP	20
	3L02R	D/I	U0	LM	20
	3L02R	D/I	U0	CM	20
	3L02R	D/I	U0	CR	20
	3L02R	D/I	U0	NS	20
Baño	Modelo	Mano	Entrada	Acabado	Embalaje
	3L03R	-	U0	LP	20
	3L03R	-	U0	LM	20
	3L03R	-	U0	CM	20
	3L03R	-	U0	CR	20
	3L03R	-	U0	NS	20
Paso	Modelo	Mano	Entrada	Acabado	Embalaje
	3L05R	-	U0	LP	20
	3L05R	-	U0	LM	20
	3L05R	-	U0	CM	20
	3L05R	-	U0	CR	20
	3L05R	-	U0	NS	20

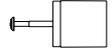
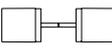
Oficinas	Modelo	Mano	Entrada	Acabado	Embalaje
	3L07R	-	U0	LP	20
	3L07R	-	U0	LM	20
	3L07R	-	U0	CM	20
	3L07R	-	U0	CR	20
	3L07R	-	U0	NS	20
Tirador	Modelo	Mano	Entrada	Acabado	Embalaje
	3L31R	D/I	00	LP	20
	3L31R	D/I	00	LM	20
	3L31R	D/I	00	CM	20
	3L31R	D/I	00	CR	20
	3L31R	D/I	00	NS	20
Doble tirador	Modelo	Mano	Entrada	Acabado	Embalaje
	3L32R	-	00	LP	20
	3L32R	-	00	LM	20
	3L32R	-	00	CM	20
	3L32R	-	00	CR	20
	3L32R	-	00	NS	20
Doble cuadradillo	Modelo	Mano	Entrada	Acabado	Embalaje
	3L33R	-	00	LP	20
	3L33R	-	00	LM	20
	3L33R	-	00	CM	20
	3L33R	-	00	CR	20
	3L33R	-	00	NS	20
Cuadradillo	Modelo	Mano	Entrada	Acabado	Embalaje
	3L34R	D/I	00	LP	20
	3L34R	D/I	00	LM	20
	3L34R	D/I	00	CM	20
	3L34R	D/I	00	CR	20
	3L34R	D/I	00	NS	20



# Puertas de madera y metálicas: roseta 50 mm

Mira 

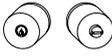
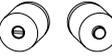
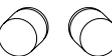
Entrada	Modelo	Mano	Entrada	Acabado	Embalaje
	3M00R	-	U0	LP	20
	3M00R	-	U0	LM	20
	3M00R	-	U0	CM	20
	3M00R	-	U0	CR	20
	3M00R	-	U0	NS	20
Aula	Modelo	Mano	Entrada	Acabado	Embalaje
	3M02R	-	U0	LP	20
	3M02R	-	U0	LM	20
	3M02R	-	U0	CM	20
	3M02R	-	U0	CR	20
	3M02R	-	U0	NS	20
Baño	Modelo	Mano	Entrada	Acabado	Embalaje
	3M03R	-	U0	LP	20
	3M03R	-	U0	LM	20
	3M03R	-	U0	CM	20
	3M03R	-	U0	CR	20
	3M03R	-	U0	NS	20
Paso	Modelo	Mano	Entrada	Acabado	Embalaje
	3M05R	-	U0	LP	20
	3M05R	-	U0	LM	20
	3M05R	-	U0	CM	20
	3M05R	-	U0	CR	20
	3M05R	-	U0	NS	20

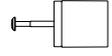
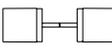
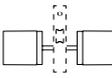
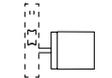
Oficinas	Modelo	Mano	Entrada	Acabado	Embalaje
	3M07R	-	U0	LP	20
	3M07R	-	U0	LM	20
	3M07R	-	U0	CM	20
	3M07R	-	U0	CR	20
	3M07R	-	U0	NS	20
Tirador	Modelo	Mano	Entrada	Acabado	Embalaje
	3M31R	-	00	LP	20
	3M31R	-	00	LM	20
	3M31R	-	00	CM	20
	3M31R	-	00	CR	20
	3M31R	-	00	NS	20
Doble tirador	Modelo	Mano	Entrada	Acabado	Embalaje
	3M32R	-	00	LP	20
	3M32R	-	00	LM	20
	3M32R	-	00	CM	20
	3M32R	-	00	CR	20
	3M32R	-	00	NS	20
Doble cuadradillo	Modelo	Mano	Entrada	Acabado	Embalaje
	3M33R	-	00	LP	20
	3M33R	-	00	LM	20
	3M33R	-	00	CM	20
	3M33R	-	00	CR	20
	3M33R	-	00	NS	20
Cuadradillo	Modelo	Mano	Entrada	Acabado	Embalaje
	3M34R	-	00	LP	20
	3M34R	-	00	LM	20
	3M34R	-	00	CM	20
	3M34R	-	00	CR	20
	3M34R	-	00	NS	20



# Puertas de madera y metálicas: escudo 65 mm

Coma 

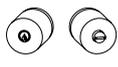
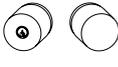
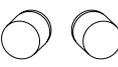
Entrada	Modelo	Mano	Entrada	Acabado	Embalaje
	3C00	-	U0	LP	20
	3C00	-	U0	LM	20
	3C00	-	U0	CM	20
	3C00	-	U0	CR	20
	3C00	-	U0	NS	20
Aula	Modelo	Mano	Entrada	Acabado	Embalaje
	3C02	D/I	U0	LP	20
	3C02	D/I	U0	LM	20
	3C02	D/I	U0	CM	20
	3C02	D/I	U0	CR	20
	3C02	D/I	U0	NS	20
Baño	Modelo	Mano	Entrada	Acabado	Embalaje
	3C03	-	U0	LP	20
	3C03	-	U0	LM	20
	3C03	-	U0	CM	20
	3C03	-	U0	CR	20
	3C03	-	U0	NS	20
Paso	Modelo	Mano	Entrada	Acabado	Embalaje
	3C05	-	U0	LP	20
	3C05	-	U0	LM	20
	3C05	-	U0	CM	20
	3C05	-	U0	CR	20
	3C05	-	U0	NS	20

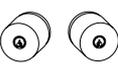
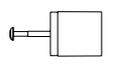
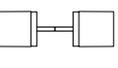
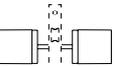
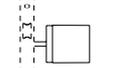
Oficinas	Modelo	Mano	Entrada	Acabado	Embalaje
	3C07	-	U0	LP	20
	3C07	-	U0	LM	20
	3C07	-	U0	CM	20
	3C07	-	U0	CR	20
	3C07	-	U0	NS	20
Tirador	Modelo	Mano	Entrada	Acabado	Embalaje
	3C31	D/I	00	LP	20
	3C31	D/I	00	LM	20
	3C31	D/I	00	CM	20
	3C31	D/I	00	CR	20
	3C31	D/I	00	NS	20
Doble tirador	Modelo	Mano	Entrada	Acabado	Embalaje
	3C32	-	00	LP	20
	3C32	-	00	LM	20
	3C32	-	00	CM	20
	3C32	-	00	CR	20
	3C32	-	00	NS	20
Doble cuadradillo	Modelo	Mano	Entrada	Acabado	Embalaje
	3C33	-	00	LP	20
	3C33	-	00	LM	20
	3C33	-	00	CM	20
	3C33	-	00	CR	20
	3C33	-	00	NS	20
Cuadradillo	Modelo	Mano	Entrada	Acabado	Embalaje
	3C34	D/I	00	LP	20
	3C34	D/I	00	LM	20
	3C34	D/I	00	CM	20
	3C34	D/I	00	CR	20
	3C34	D/I	00	NS	20



# Puertas de madera y metálicas: escudo 65 mm

Luna 

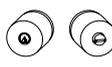
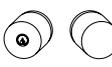
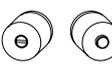
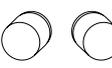
Entrada	Modelo	Mano	Entrada	Acabado	Embalaje
	3L00	-	U0	LP	20
	3L00	-	U0	LM	20
	3L00	-	U0	CM	20
	3L00	-	U0	CR	20
	3L00	-	U0	NS	20
Aula	Modelo	Mano	Entrada	Acabado	Embalaje
	3L02	D/I	U0	LP	20
	3L02	D/I	U0	LM	20
	3L02	D/I	U0	CM	20
	3L02	D/I	U0	CR	20
	3L02	D/I	U0	NS	20
Baño	Modelo	Mano	Entrada	Acabado	Embalaje
	3L03	-	U0	LP	20
	3L03	-	U0	LM	20
	3L03	-	U0	CM	20
	3L03	-	U0	CR	20
	3L03	-	U0	NS	20
Paso	Modelo	Mano	Entrada	Acabado	Embalaje
	3L05	-	U0	LP	20
	3L05	-	U0	LM	20
	3L05	-	U0	CM	20
	3L05	-	U0	CR	20
	3L05	-	U0	NS	20

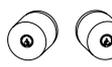
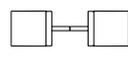
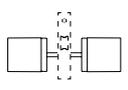
Oficinas	Modelo	Mano	Entrada	Acabado	Embalaje
	3L07	-	U0	LP	20
	3L07	-	U0	LM	20
	3L07	-	U0	CM	20
	3L07	-	U0	CR	20
	3L07	-	U0	NS	20
Tirador	Modelo	Mano	Entrada	Acabado	Embalaje
	3L31	D/I	00	LP	20
	3L31	D/I	00	LM	20
	3L31	D/I	00	CM	20
	3L31	D/I	00	CR	20
	3L31	D/I	00	NS	20
Doble tirador	Modelo	Mano	Entrada	Acabado	Embalaje
	3L32	-	00	LP	20
	3L32	-	00	LM	20
	3L32	-	00	CM	20
	3L32	-	00	CR	20
	3L32	-	00	NS	20
Doble cuadradillo	Modelo	Mano	Entrada	Acabado	Embalaje
	3L33	-	00	LP	20
	3L33	-	00	LM	20
	3L33R	-	00	CM	20
	3L33	-	00	CR	20
	3L33	-	00	NS	20
Cuadradillo	Modelo	Mano	Entrada	Acabado	Embalaje
	3L34	D/I	00	LP	20
	3L34	D/I	00	LM	20
	3L34	D/I	00	CM	20
	3L34	D/I	00	CR	20
	3L34	D/I	00	NS	20



# Puertas de madera y metálicas: escudo 65 mm

## Mira

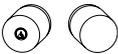
Entrada	Modelo	Mano	Entrada	Acabado	Embalaje
	3M00	-	U0	LP	20
	3M00	-	U0	LM	20
	3M00	-	U0	CM	20
	3M00	-	U0	CR	20
	3M00	-	U0	NS	20
Aula	Modelo	Mano	Entrada	Acabado	Embalaje
	3M02	-	U0	LP	20
	3M02	-	U0	LM	20
	3M02	-	U0	CM	20
	3M02	-	U0	CR	20
	3M02	-	U0	NS	20
Baño	Modelo	Mano	Entrada	Acabado	Embalaje
	3M03	-	U0	LP	20
	3M03	-	U0	LM	20
	3M03	-	U0	CM	20
	3M03	-	U0	CR	20
	3M03	-	U0	NS	20
Paso	Modelo	Mano	Entrada	Acabado	Embalaje
	3M05	-	U0	LP	20
	3M05	-	U0	LM	20
	3M05	-	U0	CM	20
	3M05	-	U0	CR	20
	3M05	-	U0	NS	20

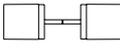
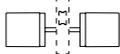
Oficinas	Modelo	Mano	Entrada	Acabado	Embalaje
	3M07	-	U0	LP	20
	3M07	-	U0	LM	20
	3M07	-	U0	CM	20
	3M07	-	U0	CR	20
	3M07	-	U0	NS	20
Tirador	Modelo	Mano	Entrada	Acabado	Embalaje
	3M31	-	00	LP	20
	3M31	-	00	LM	20
	3M31	-	00	CM	20
	3M31	-	00	CR	20
	3M31	-	00	NS	20
Doble tirador	Modelo	Mano	Entrada	Acabado	Embalaje
	3M32	-	00	LP	20
	3M32	-	00	LM	20
	3M32	-	00	CM	20
	3M32	-	00	CR	20
	3M32	-	00	NS	20
Doble cuadradillo	Modelo	Mano	Entrada	Acabado	Embalaje
	3M33	-	00	LP	20
	3M33	-	00	LM	20
	3M33	-	00	CM	20
	3M33	-	00	CR	20
	3M33	-	00	NS	20
Cuadradillo	Modelo	Mano	Entrada	Acabado	Embalaje
	3M34	-	00	LP	20
	3M34	-	00	LM	20
	3M34	-	00	CM	20
	3M34	-	00	CR	20
	3M34	-	00	NS	20







---

## **ASSA ABLOY**

Talleres de Escoriaza, S.A.U.  
Barrio Ventas, 35 • E-20305 Irun • SPAIN  
Tel.: +34 943 669 100 • Fax: +34 943 622 189  
[www.tesa.es](http://www.tesa.es)

ASSA ABLOY is the global leader in door opening solutions,  
dedicated to satisfying end-user needs for security, safety and convenience