

Instrucciones de montaje  
Assembly instructions  
Instructions de montage  
Montageanleitung

**Pitarch**  
SYSTEM KIT MUEBLES



REF. 10050

**Te aconsejamos/ We advise you / Nous vous recommandons / Wir beraten Sie**

Ordena y cuenta las piezas y herrajes

Habilita una zona para el montaje

No fuerces los tornillos y los elementos de montaje

Sigue paso a paso las instrucciones de montaje

Order and count the parts and fittings

Enable an area for assembling.

Do not force the screws or assembly parts

Follow the assembly instructions step by step

Commander et compter les pièces et accessoires

Mettre en place un espace de rassemblement

N'utilisez pas de force sur les vis ou les éléments de montage

Suivre les instructions de montage étape par étape

Ordnen und zählen Sie die Teile und Armaturen

Einen Bereich für die Montage einrichten

Wenden Sie keine Gewalt auf Schrauben oder Befestigungselemente an.

Folgen Sie der schrittweisen Montageanleitung

**Herramientas necesarias/ Tools required / Les outils nécessaires / Notwendige Werkzeuge**

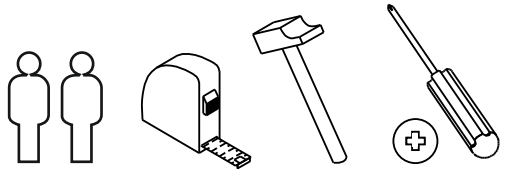

**Herrajes incluidos/ Fittings included / Matériel inclus / inklusive Hardware**

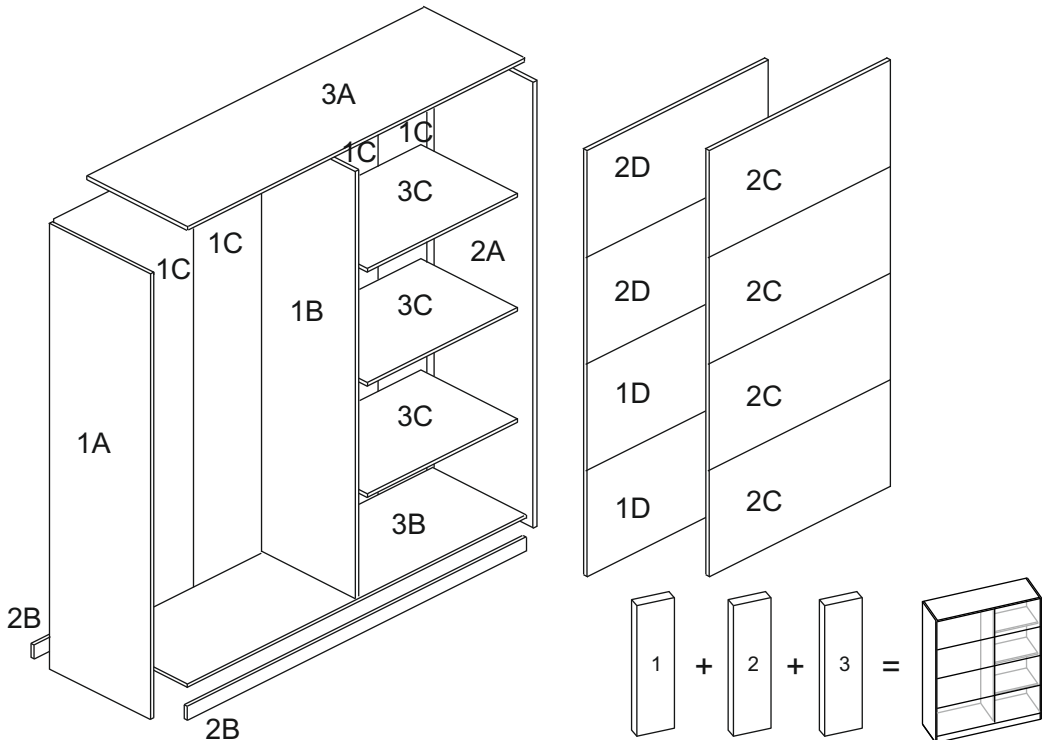



# CAJA 1 // BOX 1



2000x568 mm  
1005015

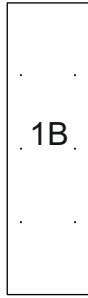

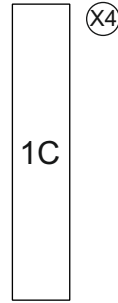

1897x540 mm  
100500

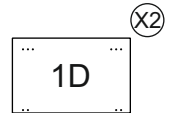

1925x373 mm  
9105075

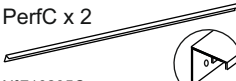
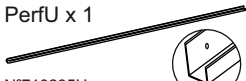

767x487 mm  
105040

<p>Guia x 1</p>  <p>N°710295ab</p>	<p>Corr x 1</p>  <p>N°710295arr</p>	<p>PerfC x 2</p>  <p>N°710295C</p>	<p>PerfU x 1</p>  <p>N°710295U</p>
--	--	---	--



# CAJA 2 // BOX 2

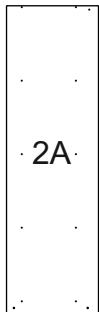

2000x595 mm  
1005014

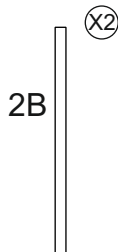

1468x70 mm  
105070

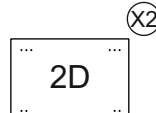

767x487 mm  
105040

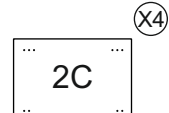

767x487 mm  
1005040

<p>Jun x 2</p>  <p>N°710056</p>
---



# CAJA 3 // BOX 3

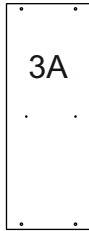

1468x548 mm  
105031

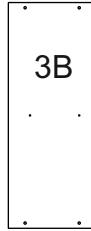

1468x560 mm  
105032

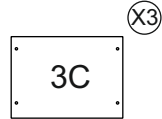

726x530 mm  
105020

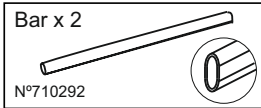

<p>Pl x 12</p> <p>N°710290</p>	<p>Exc x 20</p> <p>N°721016/721017</p>	<p>Lzgr x 1</p> <p>N°721034</p>	<p>Pun x 90</p> <p>N°721006</p>	<p>Autgr x 8</p> <p>N°721002</p>
<p>Tac x 6</p> <p>N°721045</p>	<p>Esc x 4</p> <p>N°710129</p>	<p>Sop x 4</p> <p>N°710008</p>	<p>Rei x 96</p> <p>N°721020</p>	

<p>Ginar x 1</p> <p>N°710294inar</p>	<p>Ginab x 1</p> <p>N°710294inab</p>	<p>Gexar x 2</p> <p>N°710294exar</p>	
<p>Eu x 18</p> <p>N°710294eu</p>	<p>Rei x 28</p> <p>N°710294rei</p>	<p>Torl x 4</p> <p>N°710294torl</p>	
<p>Calc x 2</p> <p>N°710294calc</p>	<p>Distiz x 2</p> <p>N°710294distiz</p>	<p>Distr x 2</p> <p>N°710294distr</p>	<p>Tope x 2</p> <p>N°710294tope</p>

# 1

Exc x 4



Corr x 1

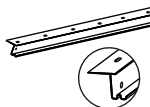

Rei x 6

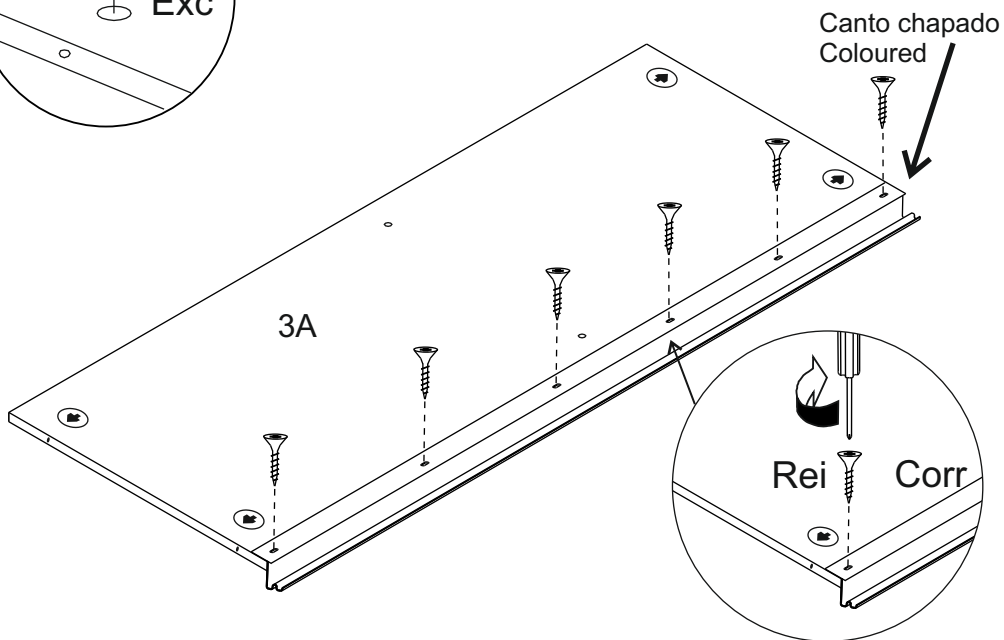
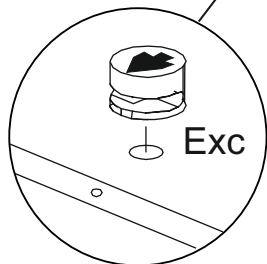
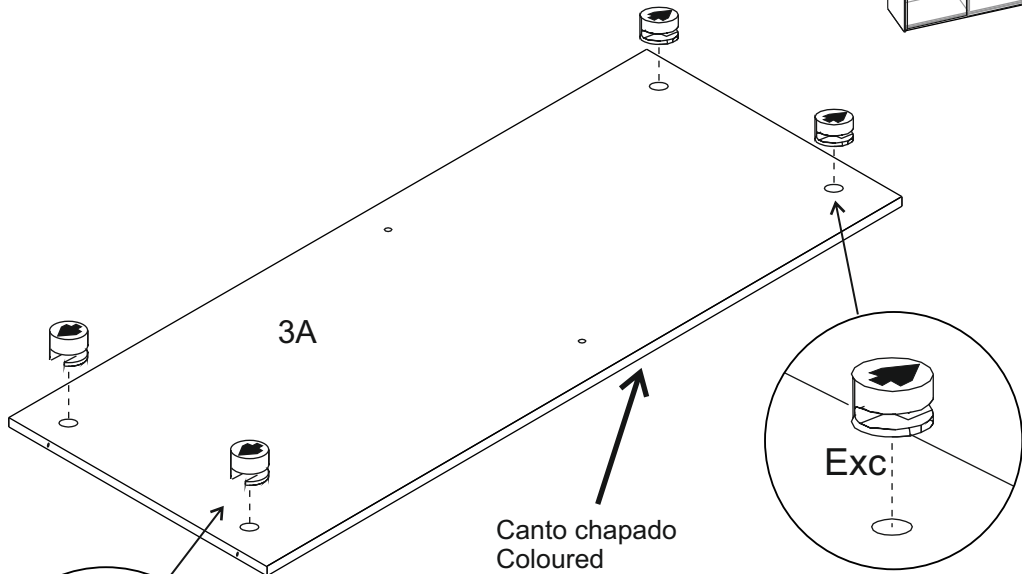
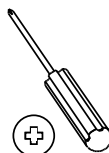

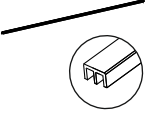
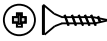
<p>Exc x 4</p> 	<p>Guia x 1</p> 	<p>Rei x 14</p> 
--	--	--

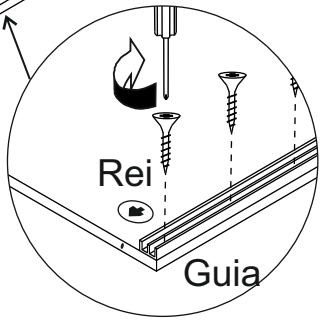
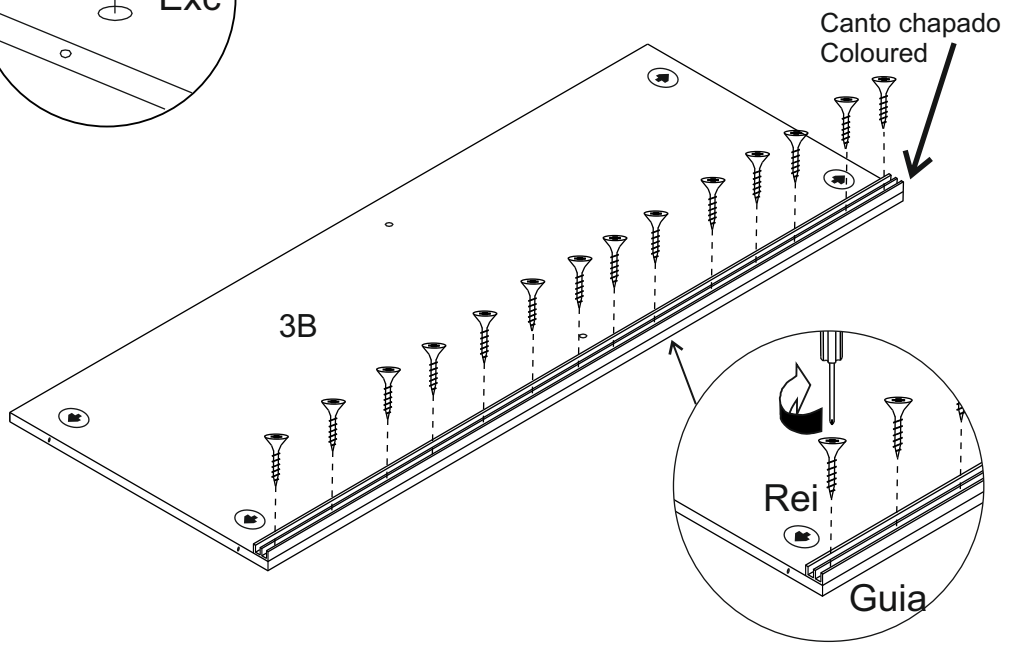
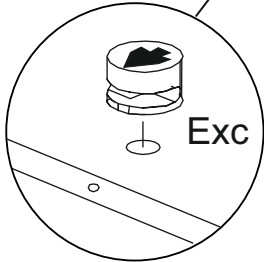
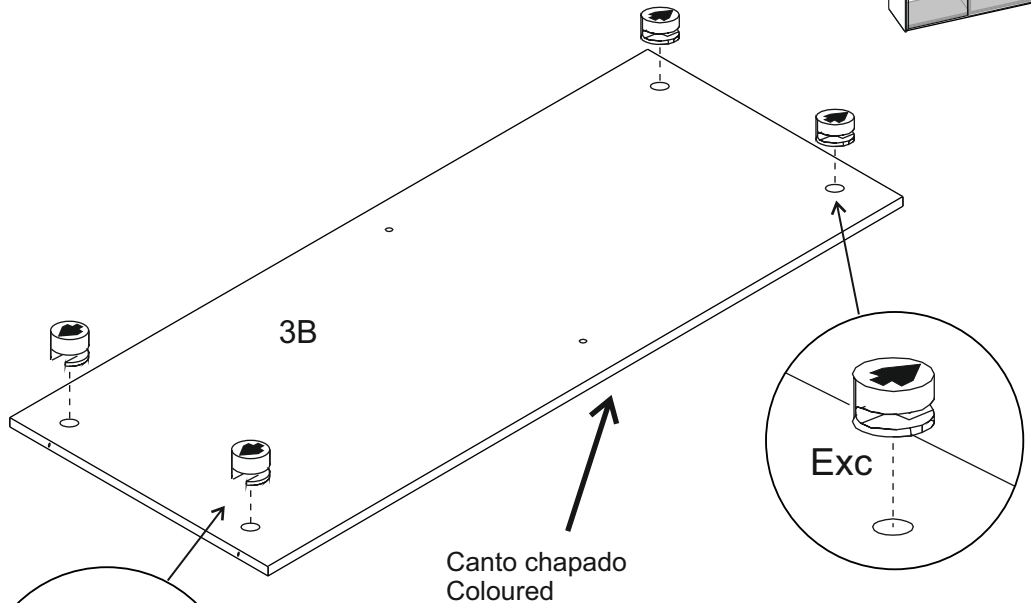
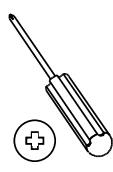

Sop x 2 	Rei x 4 	Exc x 14 	Tac x 4 	Calc x 2 	Torl x 4 	
-------------	-------------	--------------	-------------	--------------	--------------	--

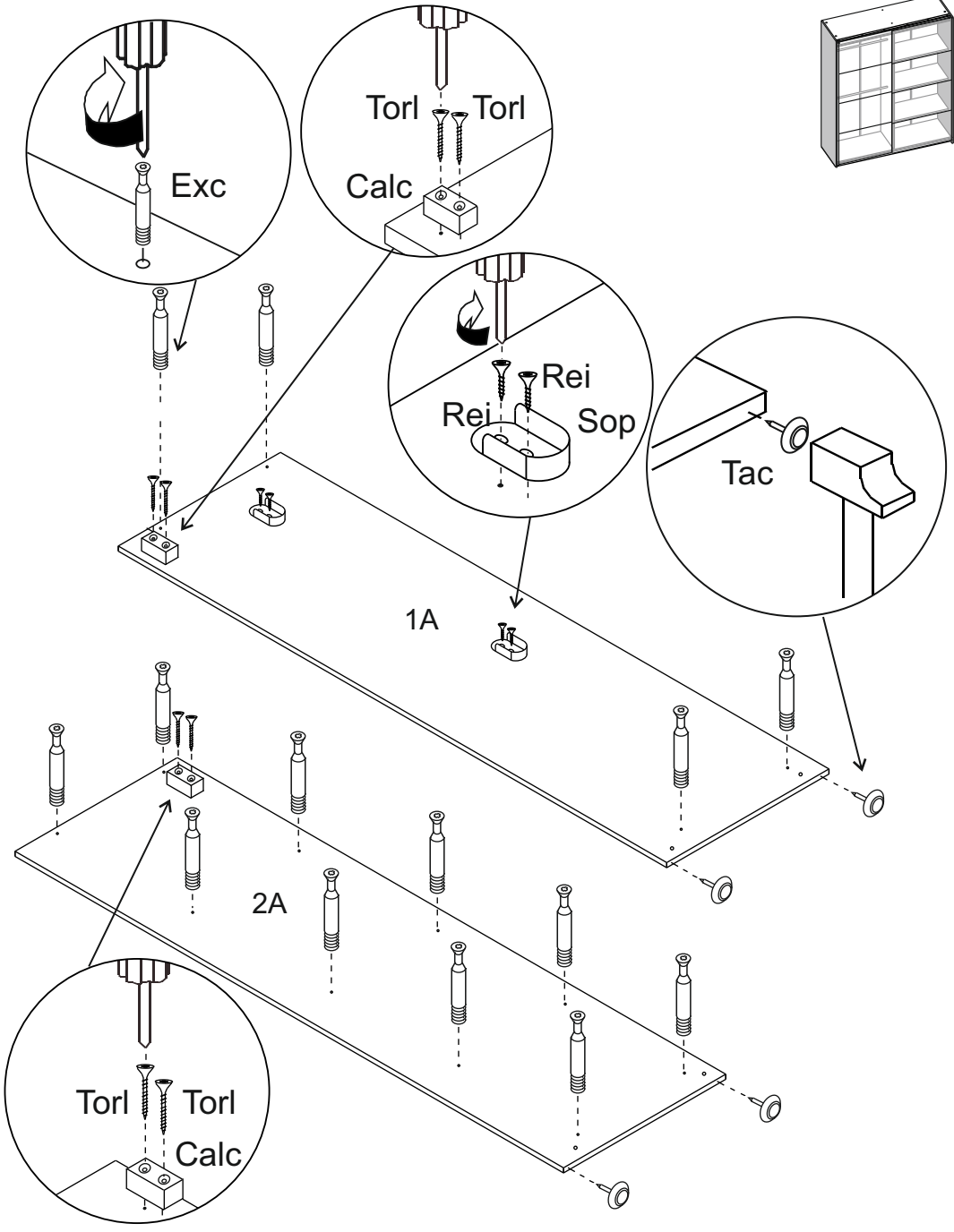
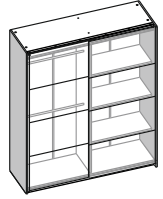

Sop x 2	Rei x 4	Exc x 6
---------	---------	---------

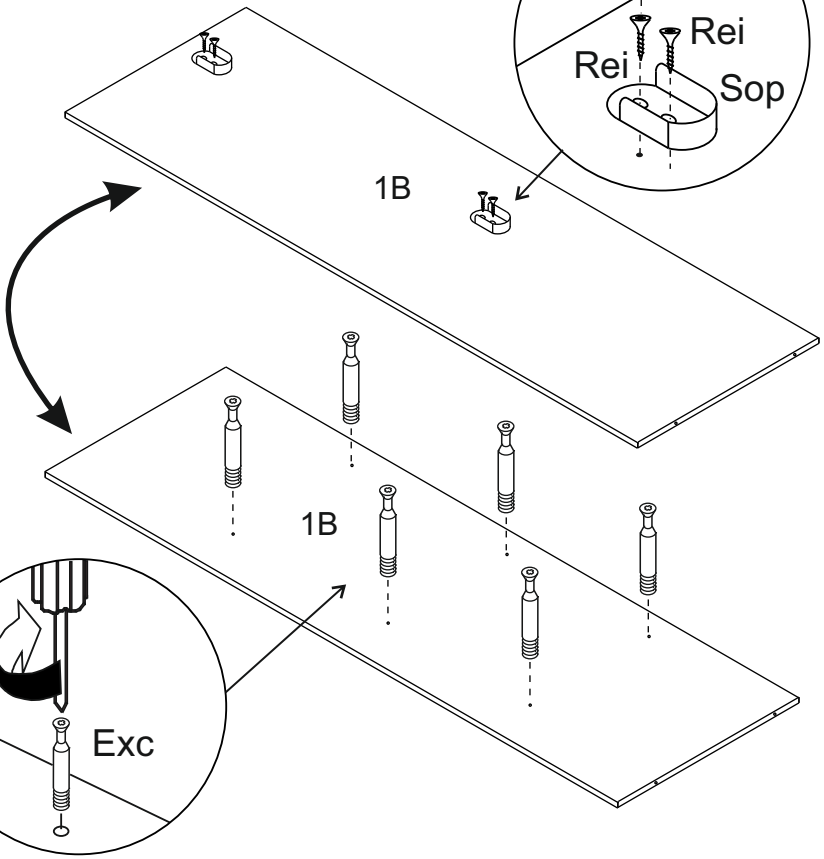
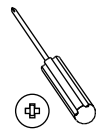

Exc x 12
----------

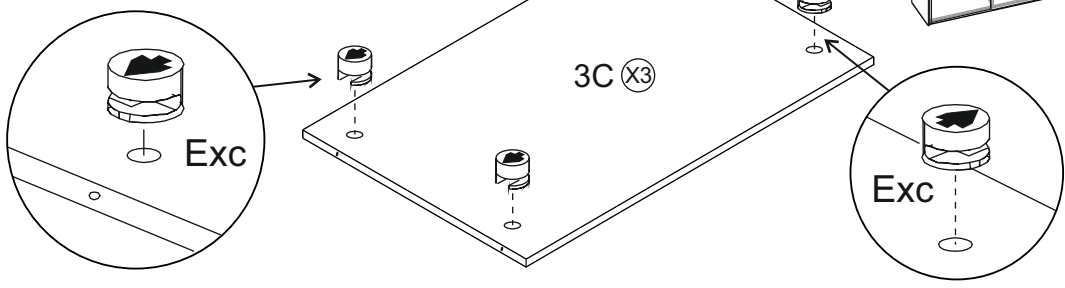
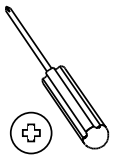



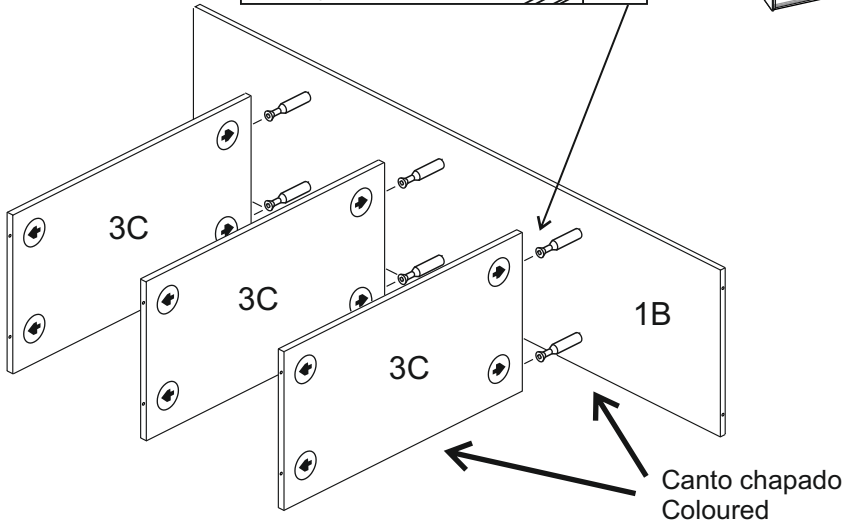
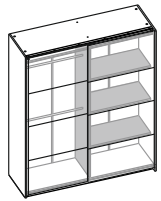
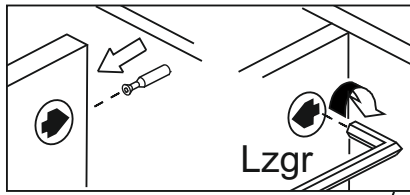

**2** Lzgr x 1

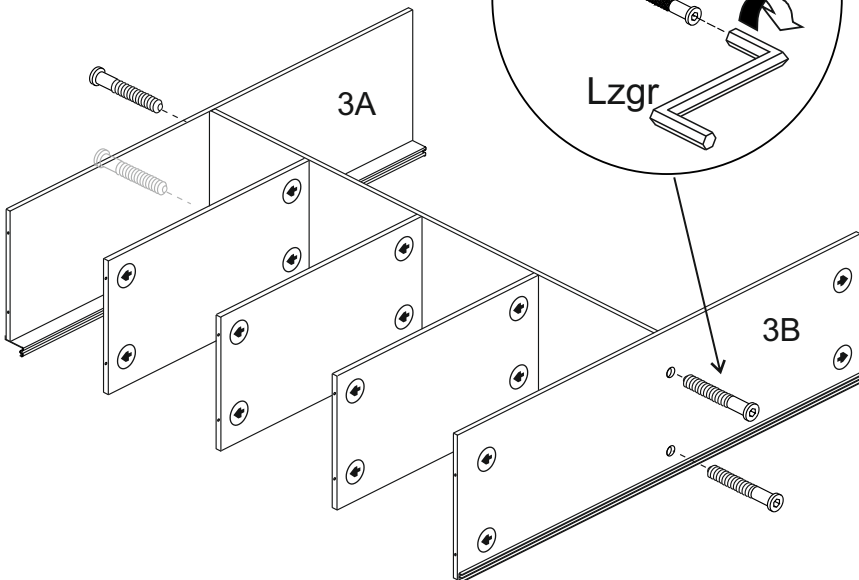
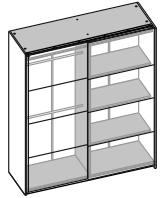
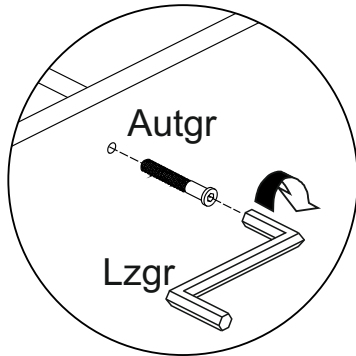

**3** Lzgr x 1 Autgr x 4

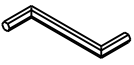

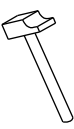
4	Lzgr x 1 	Autgr x 4 	Tac x 2 	
---	--	--	---	--

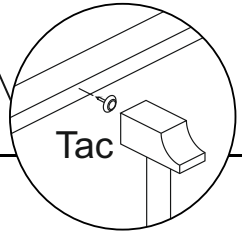
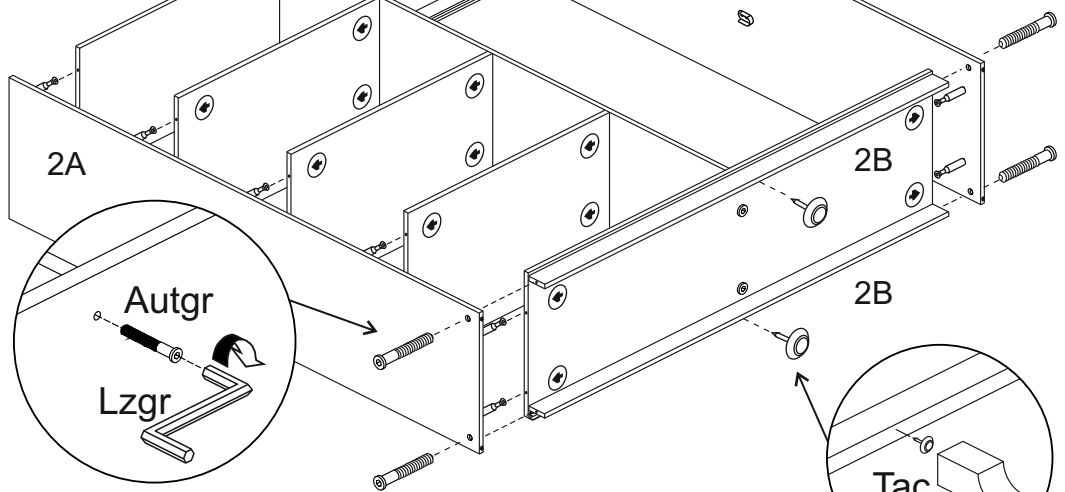
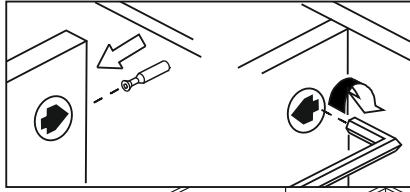
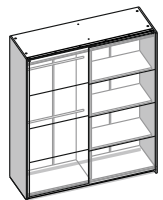

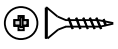
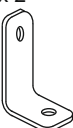
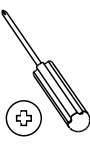
5	Rei x 4 	Esc x 2 	
---	--	---	--

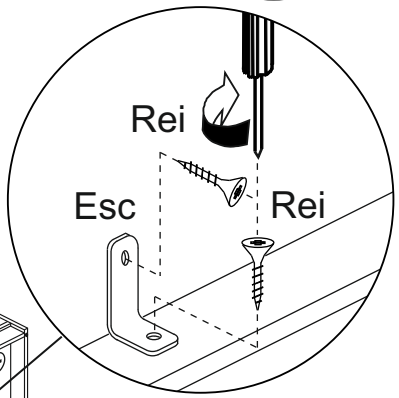
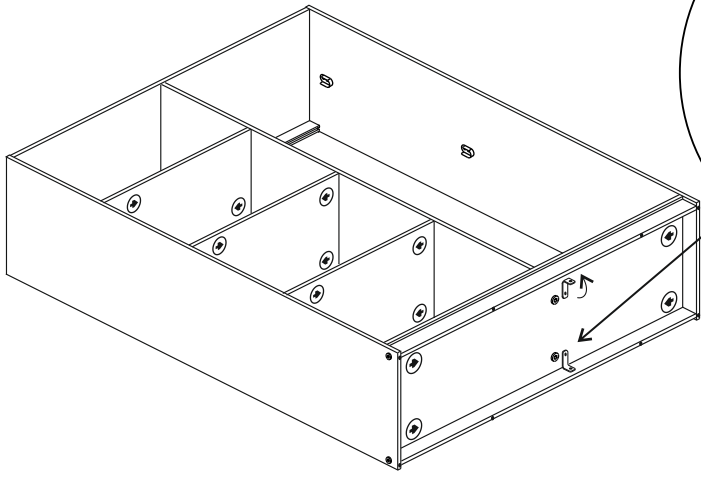

6	Pun x 90	Jun x 2
---	----------	---------

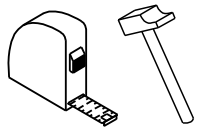

**Diagonal A = Diagonal B**

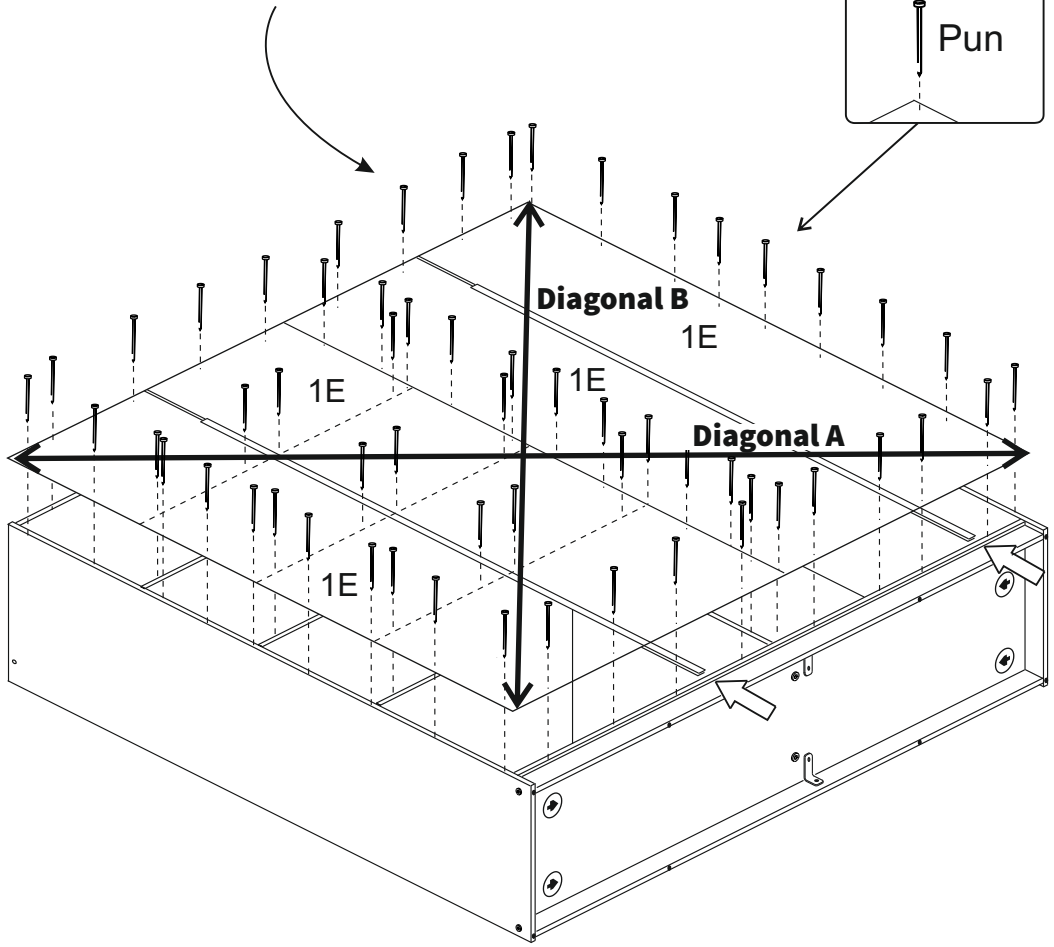
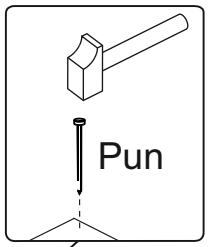

7

Bar x 2

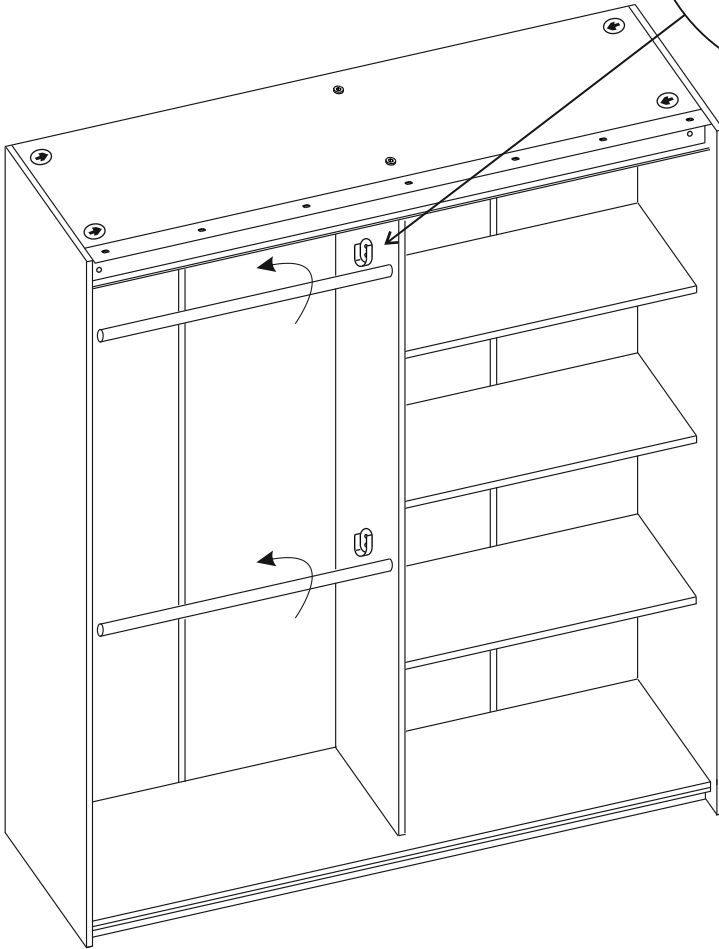
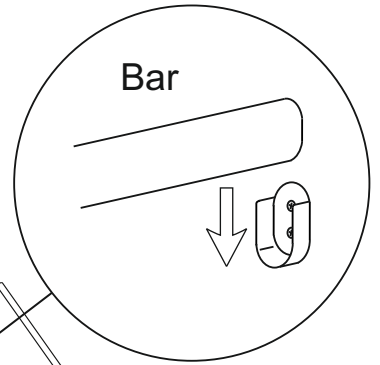
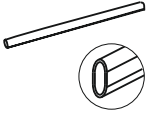

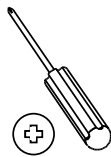
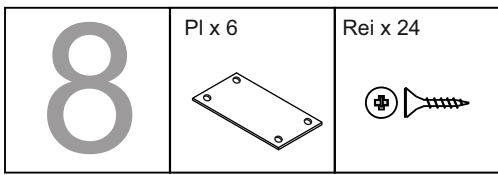

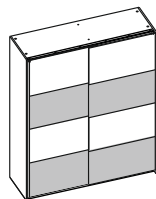
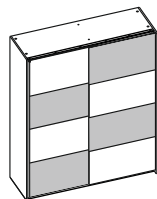
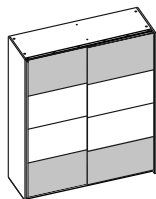
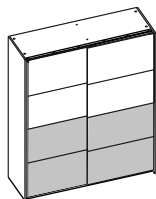
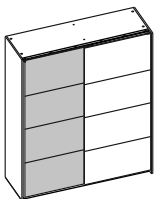
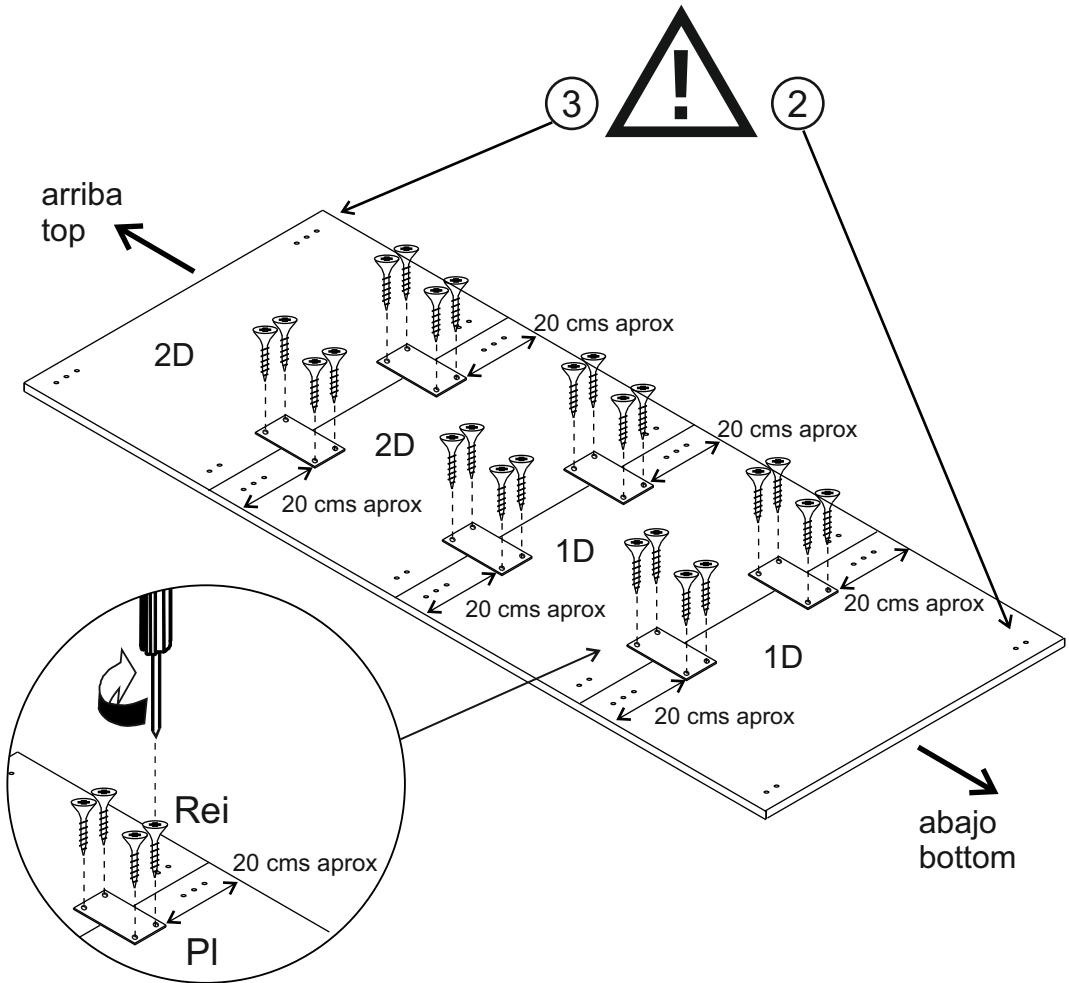

Puerta interior (izquierda)  
Inside door (left)

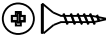

Rei x 8



PerfC x 1

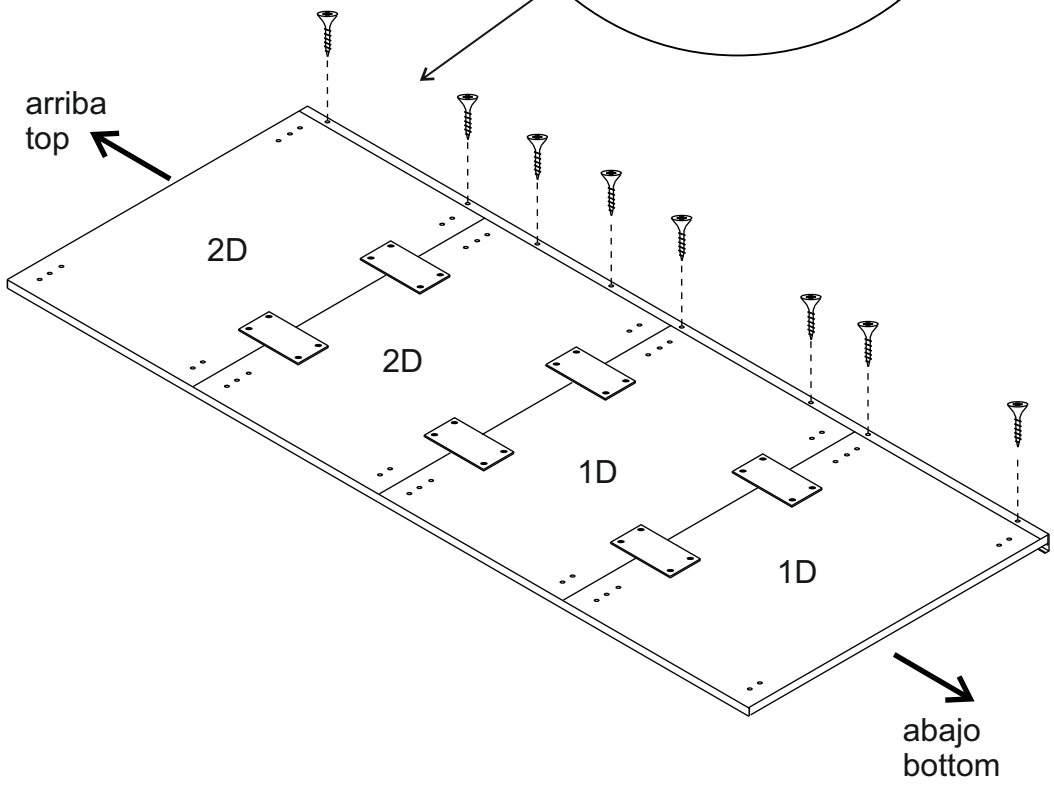
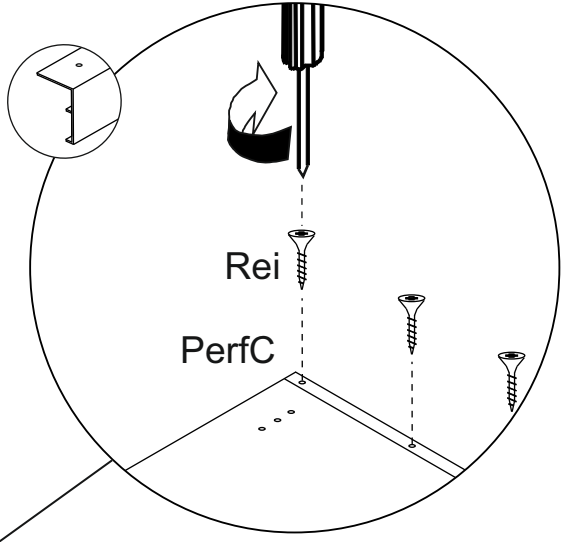
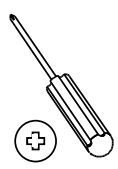

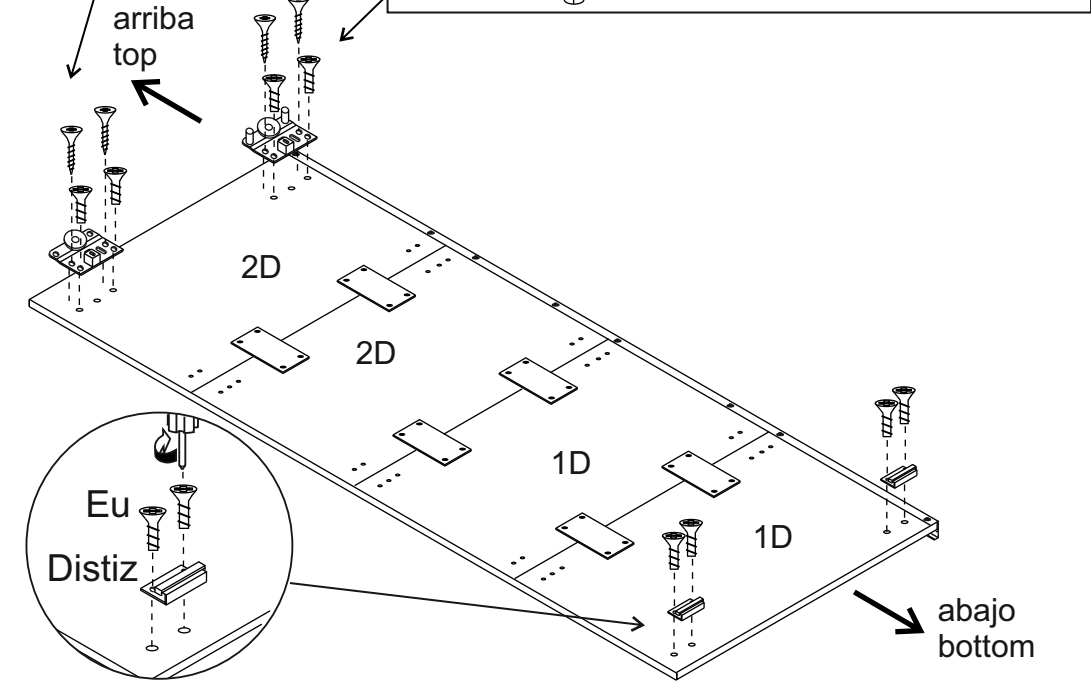
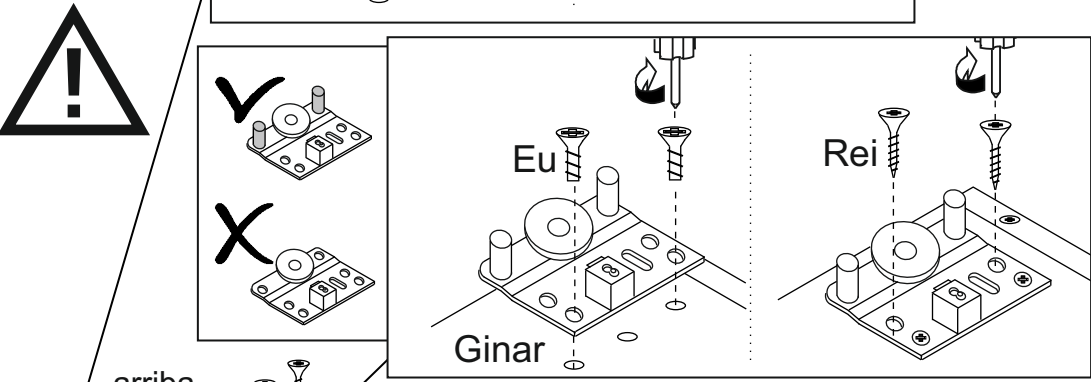
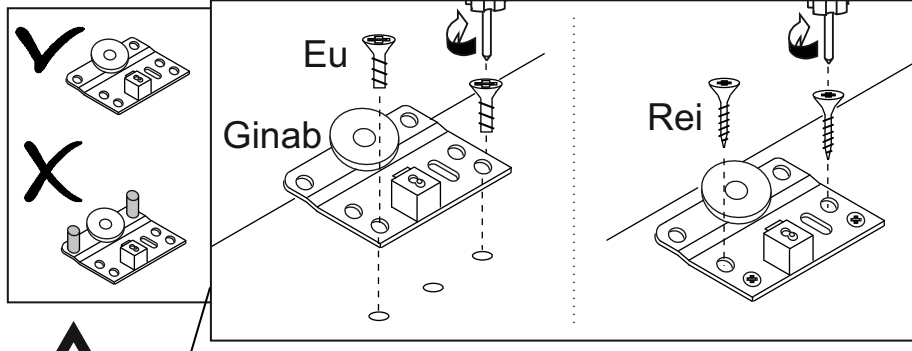
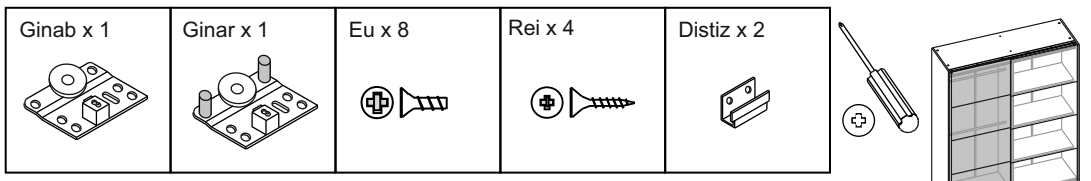

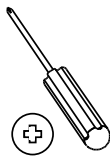
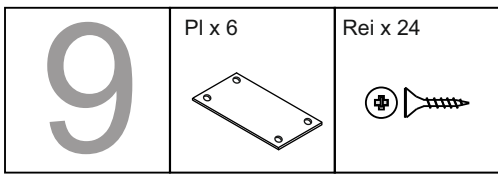
Puerta exterior (derecha)  
Outside door (right)



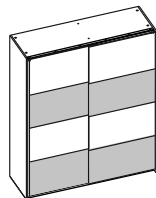
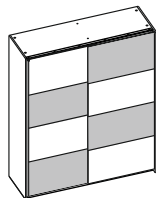
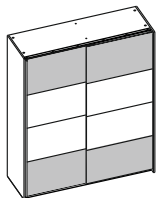
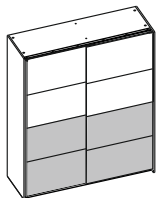
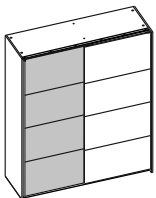
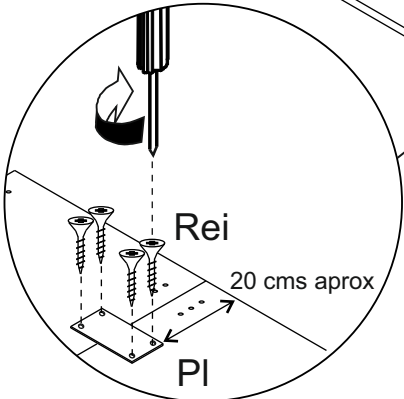
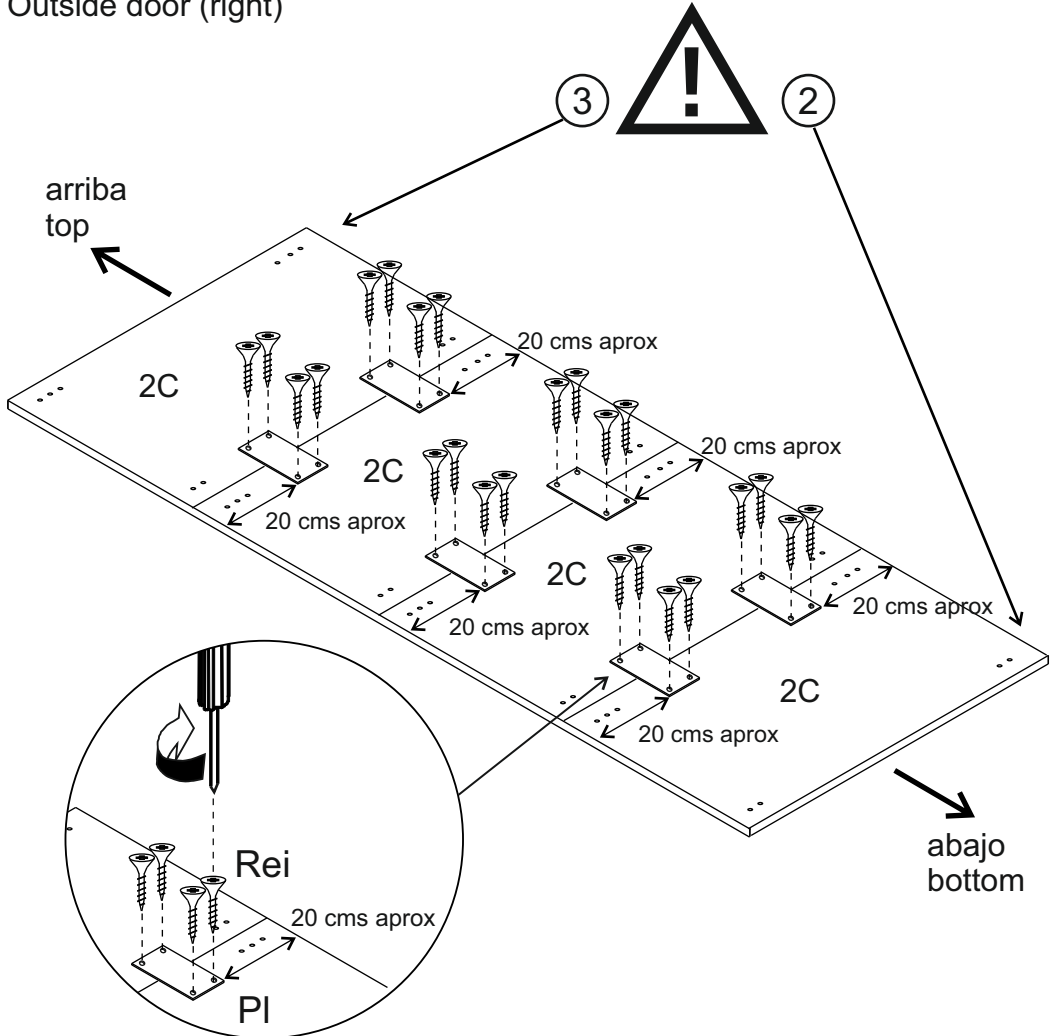

Rei x 16







PerC x 1

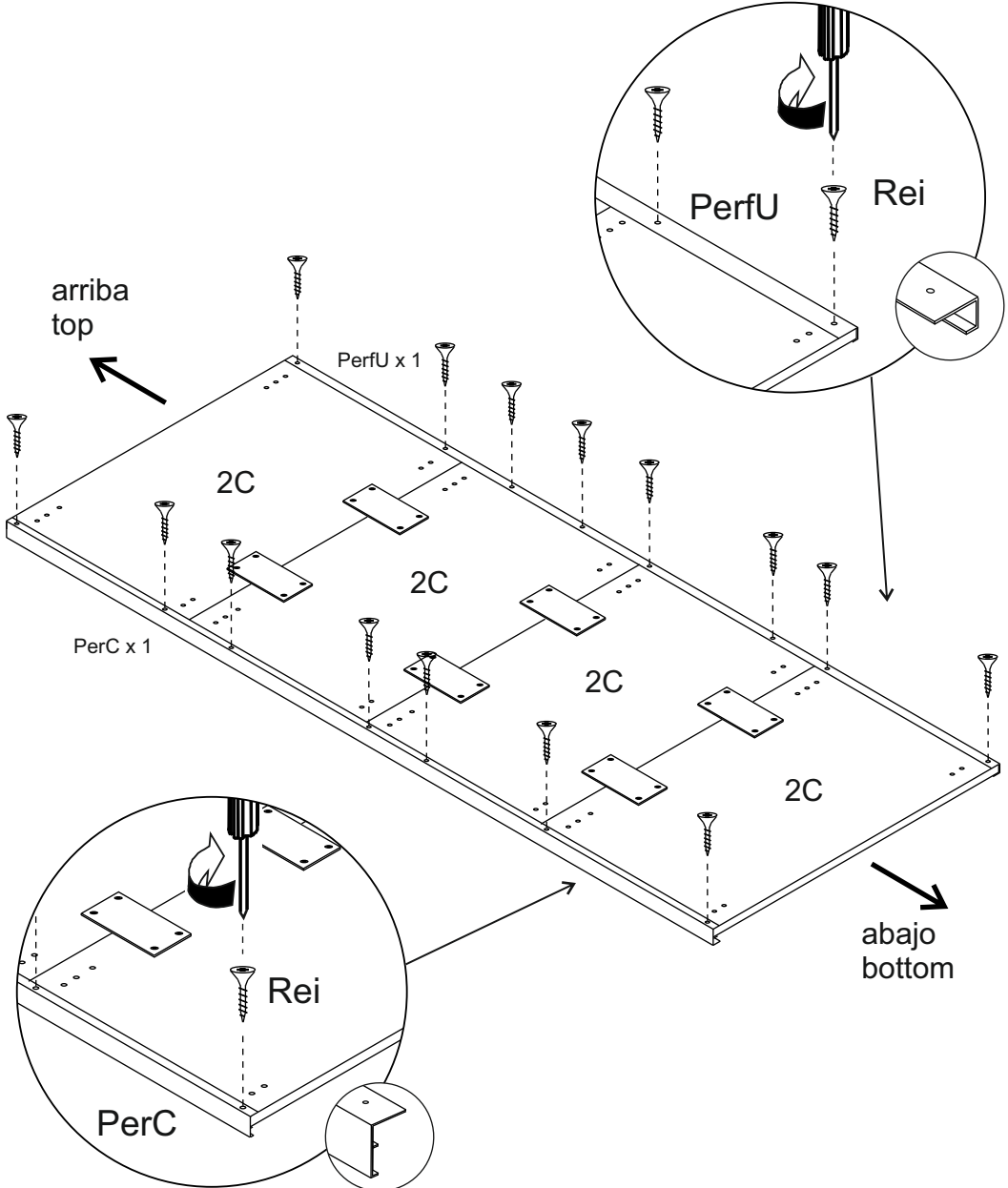
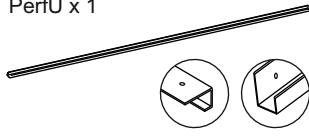

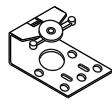
PerfU x 1

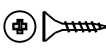

<p>Gexar x 2</p> 	<p>Eu x 10</p> 	<p>Rei x 4</p> 	<p>Distdr x 2</p> 
--	---	---	--

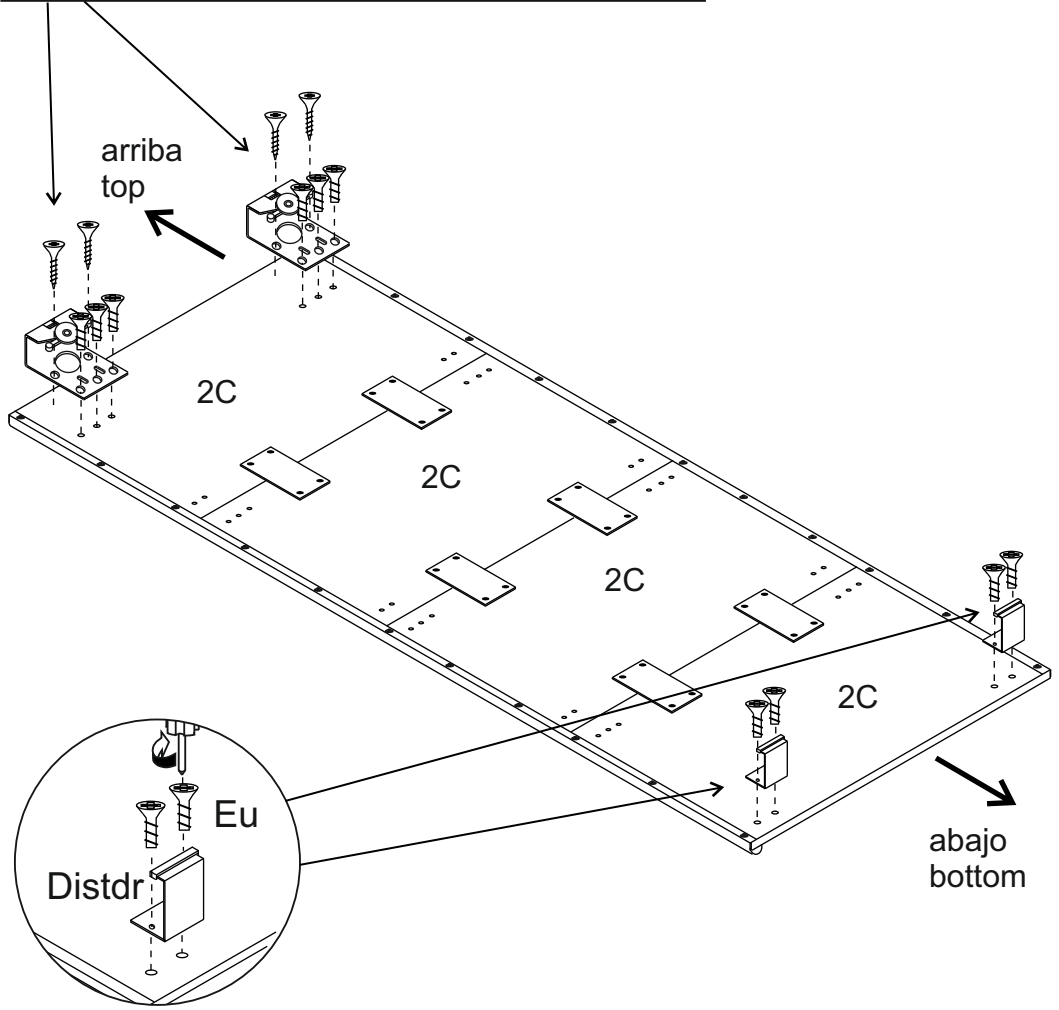
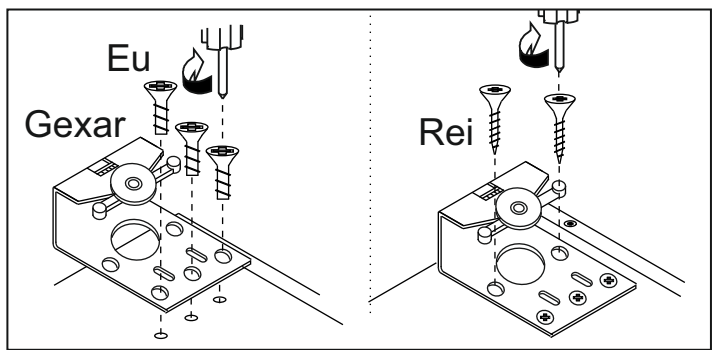
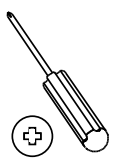

# 10

Puerta interior (izquierda)  
Inside door (left)

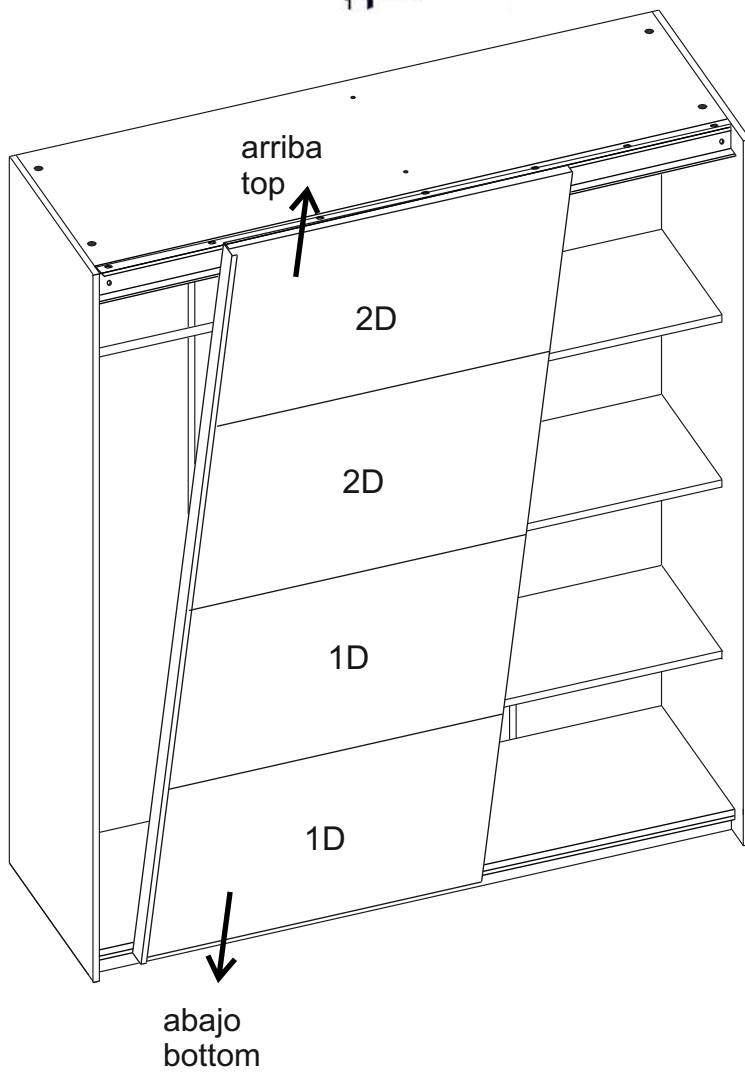
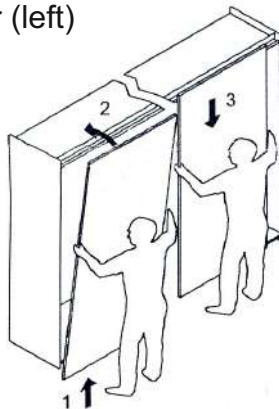
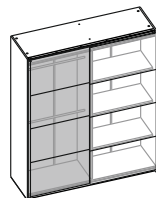

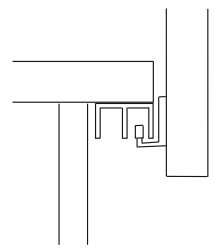
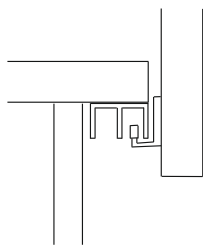
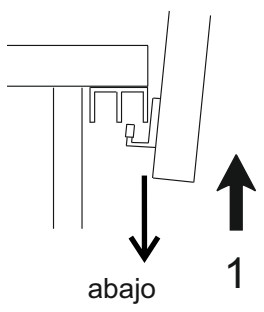
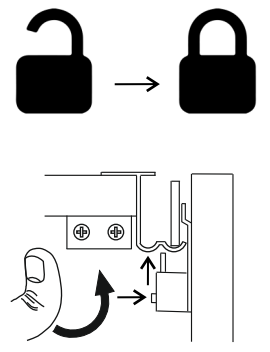
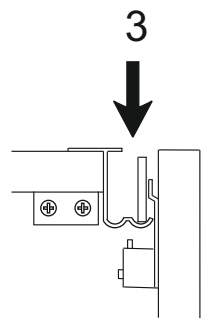
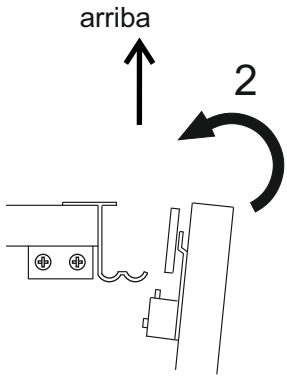

# 11

Puerta exterior (derecha)  
Outside door (right)

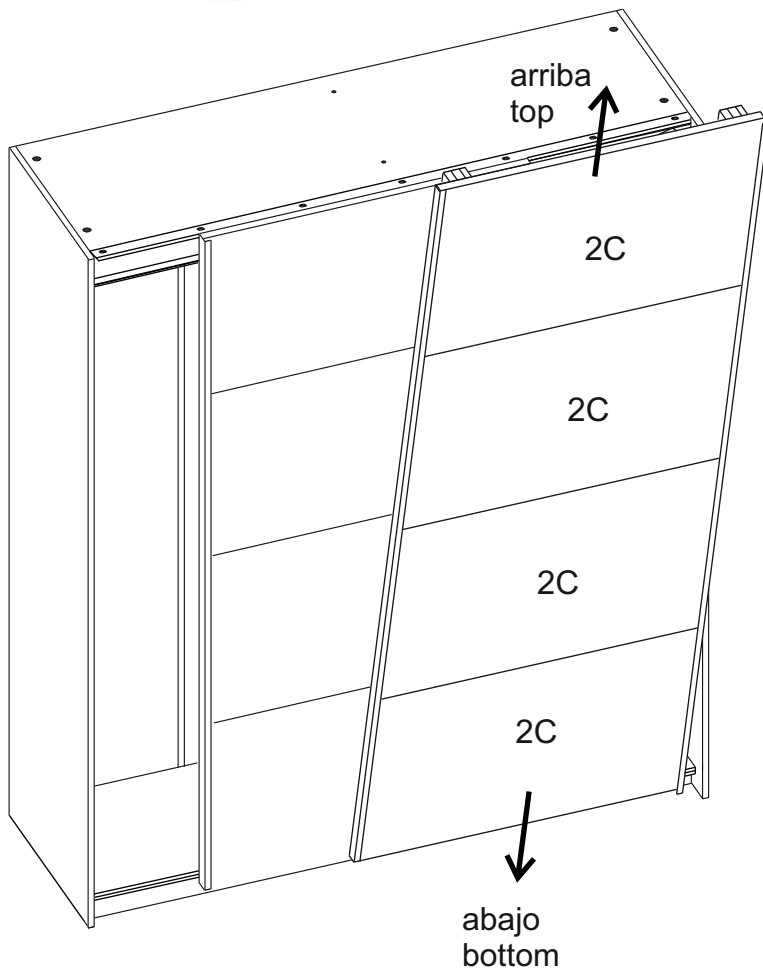
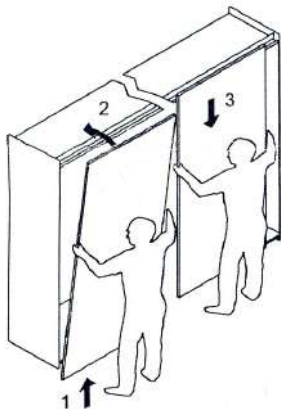
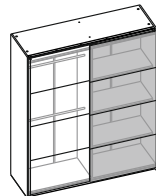

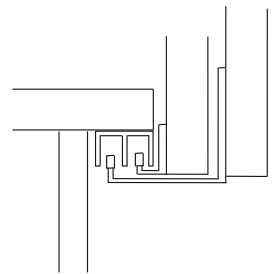
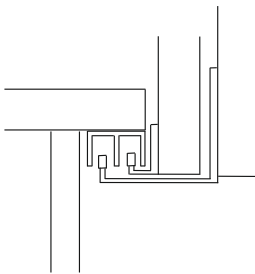
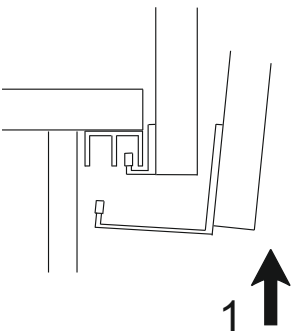
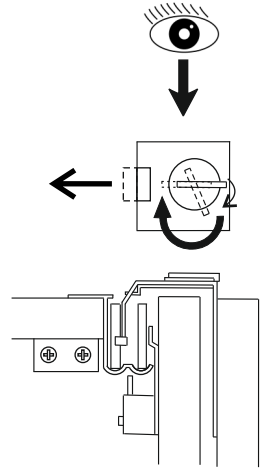
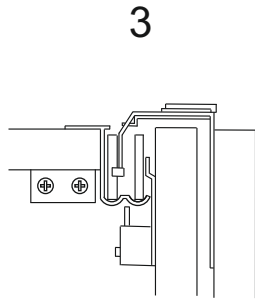
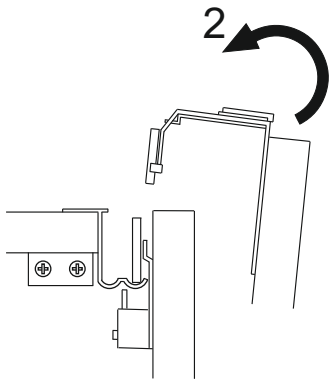
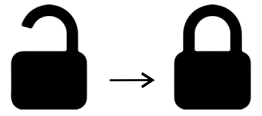

# 12

Tope x 2

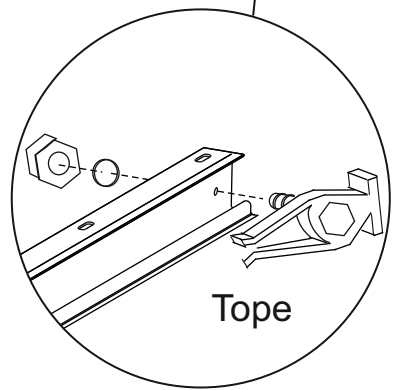
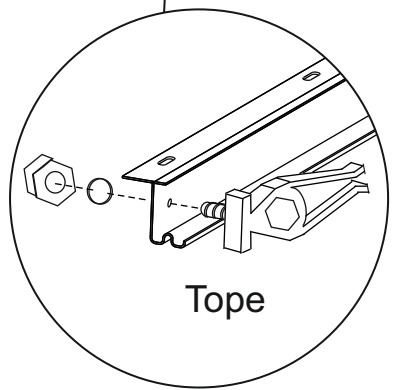
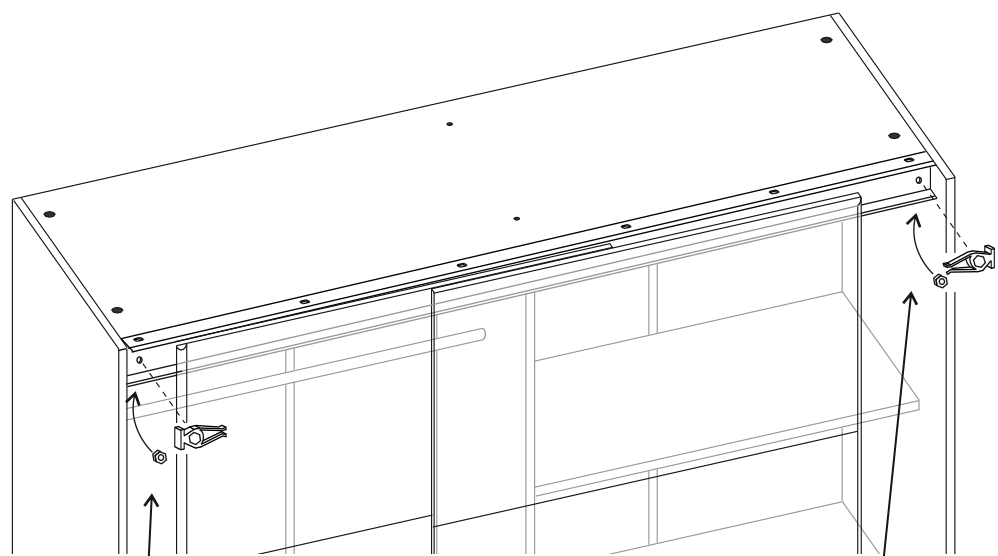
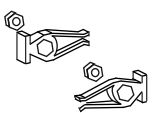

---

#### CONDICIONES DE USO Y MANTENIMIENTO

Producto de uso doméstico.

Evitar colocar el mueble cerca de fuentes de calor, de humedad o de una fuerte luz solar.

No lo limpie con productos abrasivos, ni disolventes.

Quitar el polvo antes de limpiarlo.

Utilizar un paño húmedo, limpio y sin pelos.

#### CONDITIONS OF USE AND MAINTENANCE OF FURNITURE

Product for domestic use only.

Avoid placing the furniture near sources of heat, damp, or strong sunlight.

Do not clean with abrasive products or cleaning products with solvents.

Use a dust remover before any cleaning process.

It is recommended to use a damp, lint-free clean cloth.

#### LES CONDITIONS D'UTILISATION ET D'ENTRETIEN

Produit à usage domestique.

Évitez de placer les meubles à proximité de sources de chaleur, d'humidité ou de forte lumière solaire.

Ne pas nettoyer avec des abrasifs ou des solvants.

Enlevez la poussière avant le nettoyage.

Utilisez un chiffon propre et humide.

#### EINSATZ- UND WARTUNGSBEDINGUNGEN

Produkt für den Hausgebrauch.

Vermeiden Sie die Aufstellung der Möbel in der Nähe von Wärmequellen, Feuchtigkeit oder starker Sonneneinstrahlung.

Reinigen Sie nicht mit Scheuermitteln oder Lösungsmitteln.

Entfernen Sie vor der Reinigung den Staub.

Verwenden Sie ein sauberes, feuchtes Tuch.

---

ATENCIÓN AL CLIENTE

CUSTOMER SUPPORT

**(+34)964 321 111**

8am-1pm 3pm-5:30pm Lunes a viernes  
Monday to Friday

Web: [www.mueblespitarch.com](http://www.mueblespitarch.com)  
e-mail: [comercial@mueblespitarch.com](mailto:comercial@mueblespitarch.com)

**LOTE/BATCH NUMBER**  
**5167**