

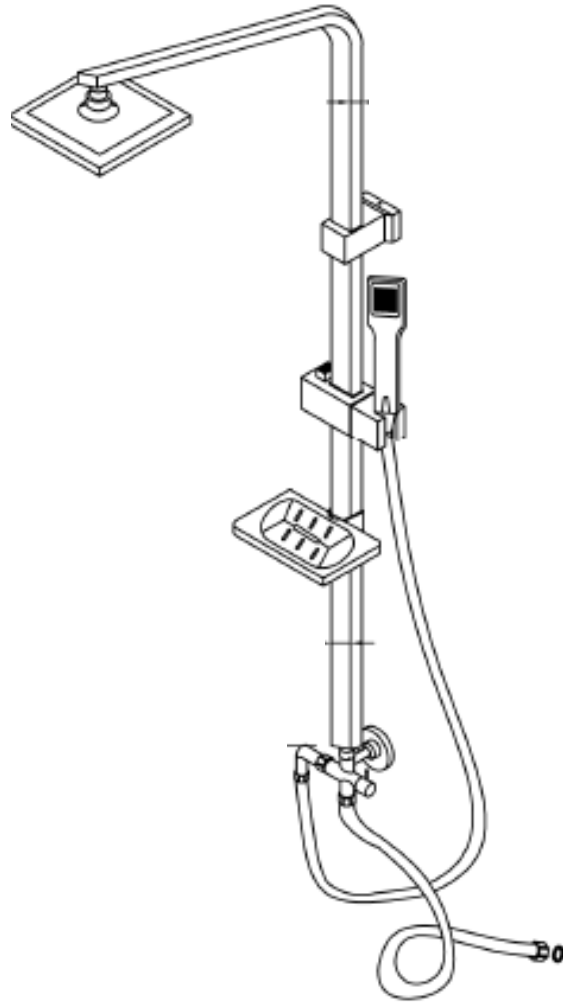









# **MANUAL DE INSTRUCCIONES COLUMNA DE HIDROMASAJE**

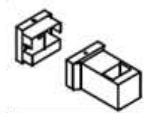





MODELO: MARS - REFERENCIA: CGRT00507

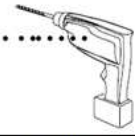
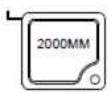

## **MATERIAL SUMINISTRADO**

X1		X4		X4		X1		X1	
X1		X6		X1		X1		X1	

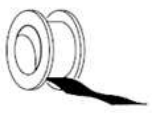
## MATERIAL NECESARIO NO SUMINISTRADO

			
TALADRO	CITA METRICA	LLAVE INGLESA	LAPIZ
			
MARTILLO PLASTICO	TEFLON	DESTORNILLADOR	

## MONTAJE DE LA COLUMNA DE HIDROMASAJE

